

LINEA 20

MAP 08

MANUALE RICAMBI

PARTS BOOK

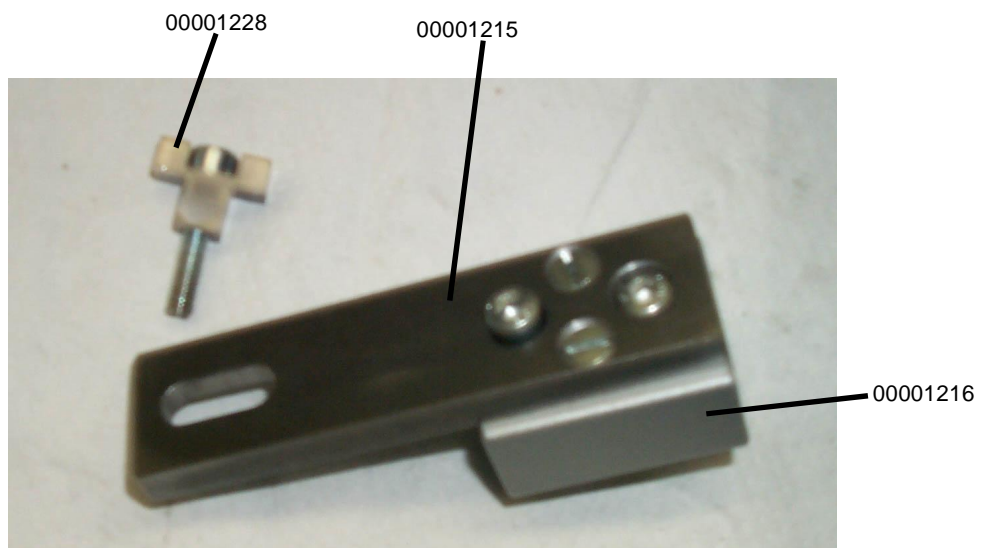
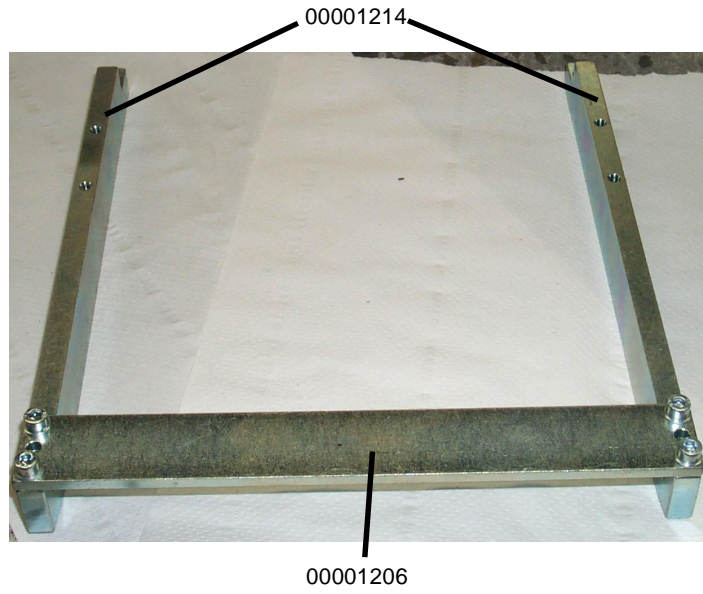
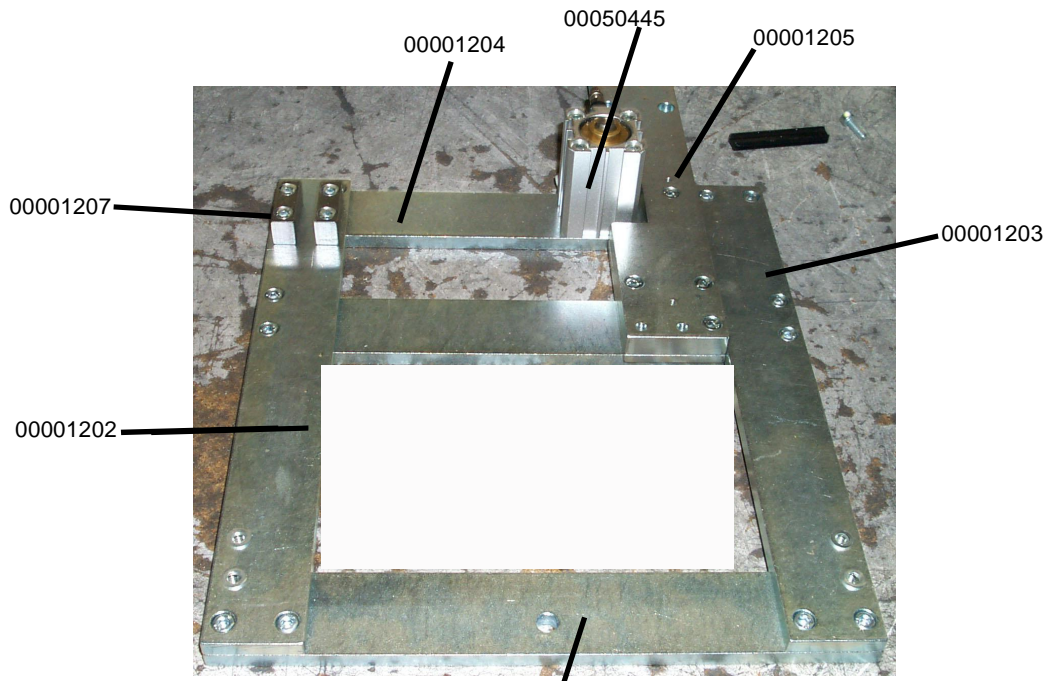

00000981 00001063 00010195 (2) 00000980 00000981

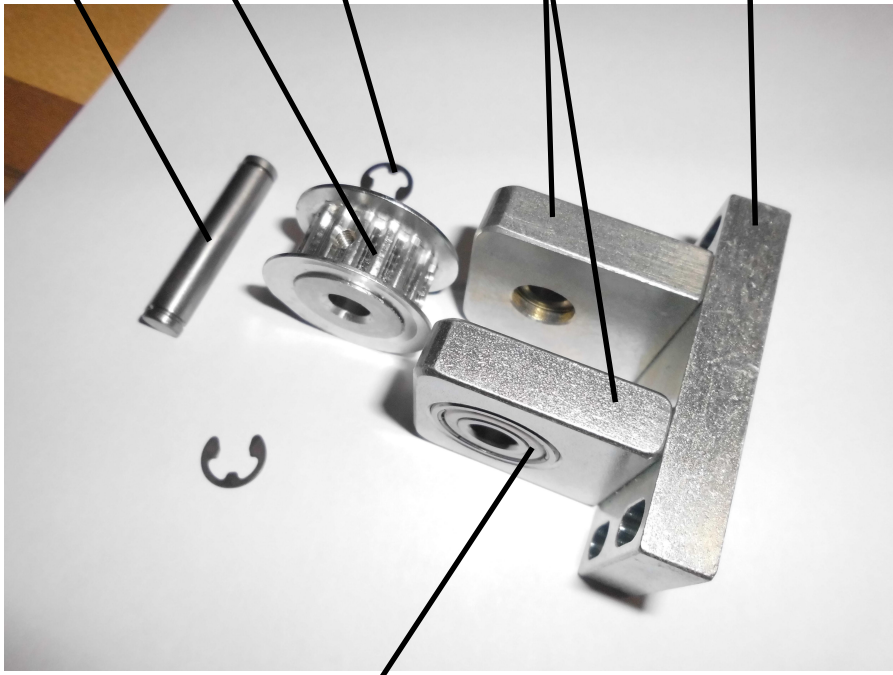

00010767 (2)

00000907 00001210 00000911 (2) 00010756 (2)

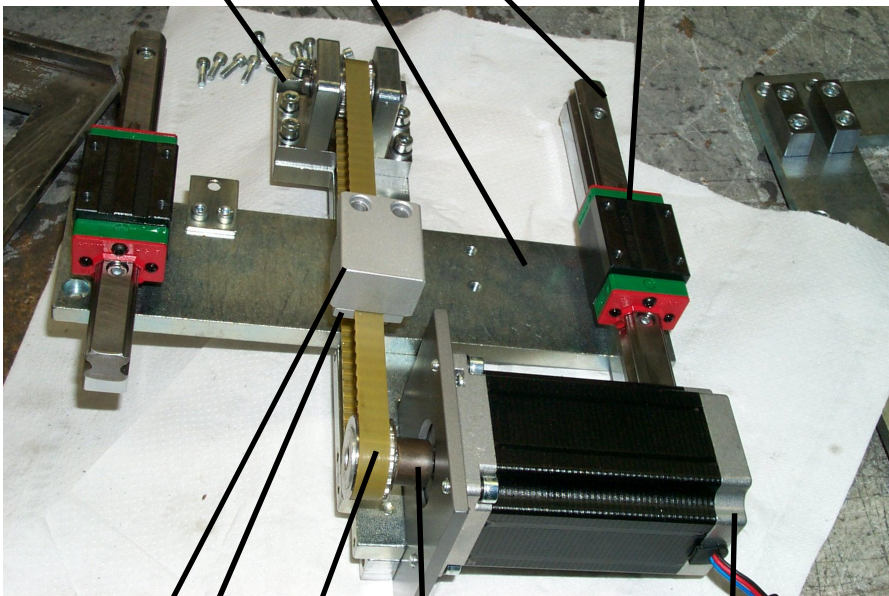

00001223 00000925 00010766 00001196 00090937

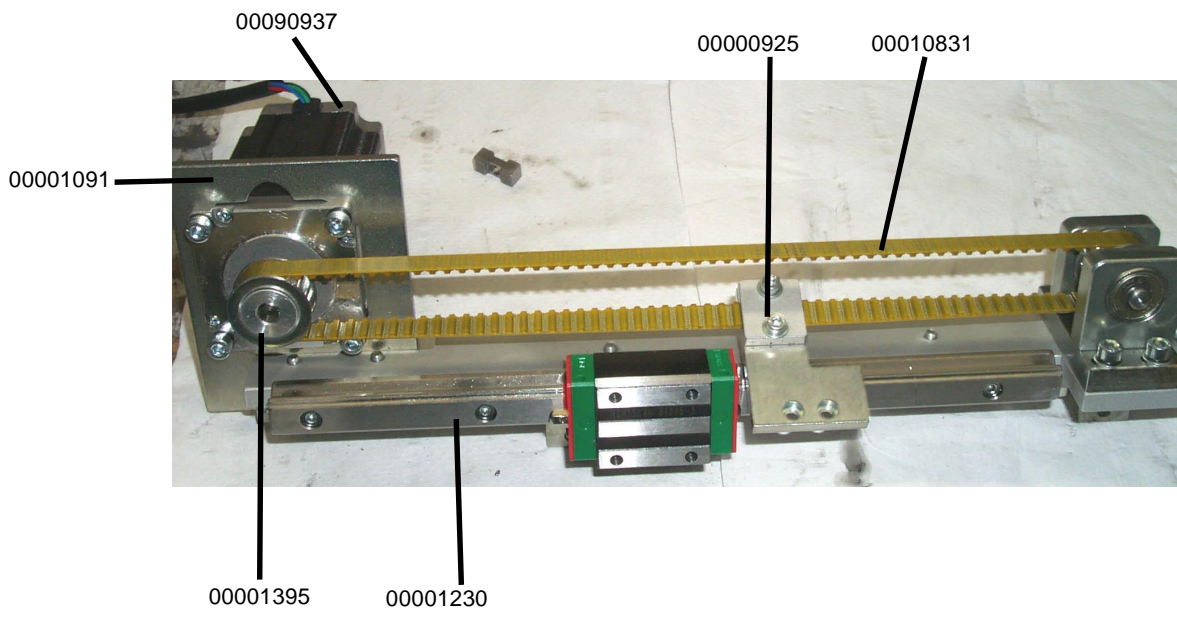
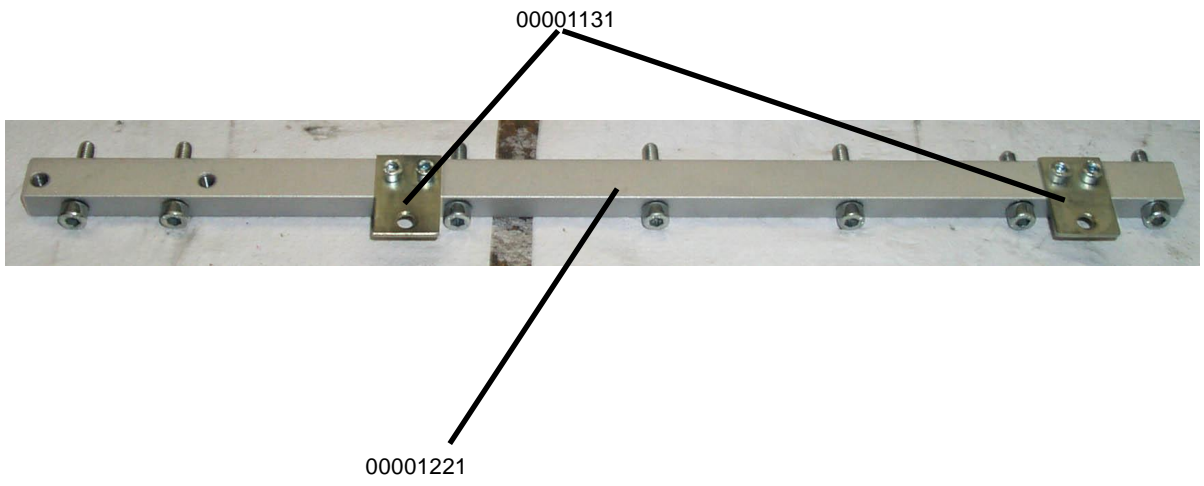

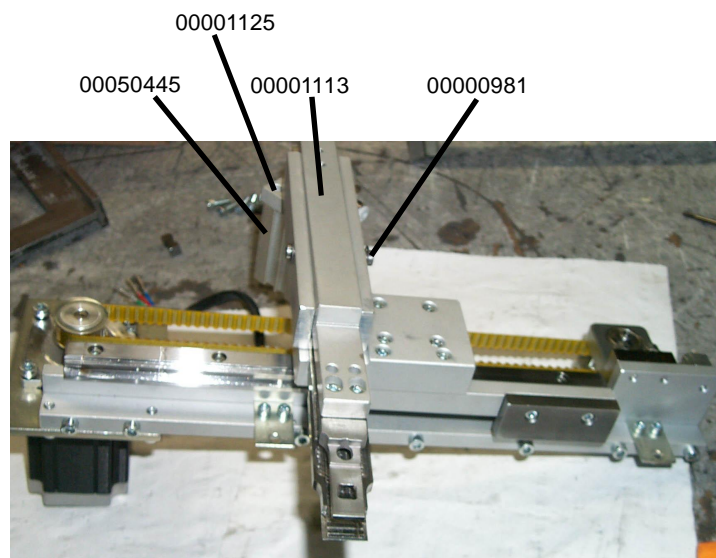
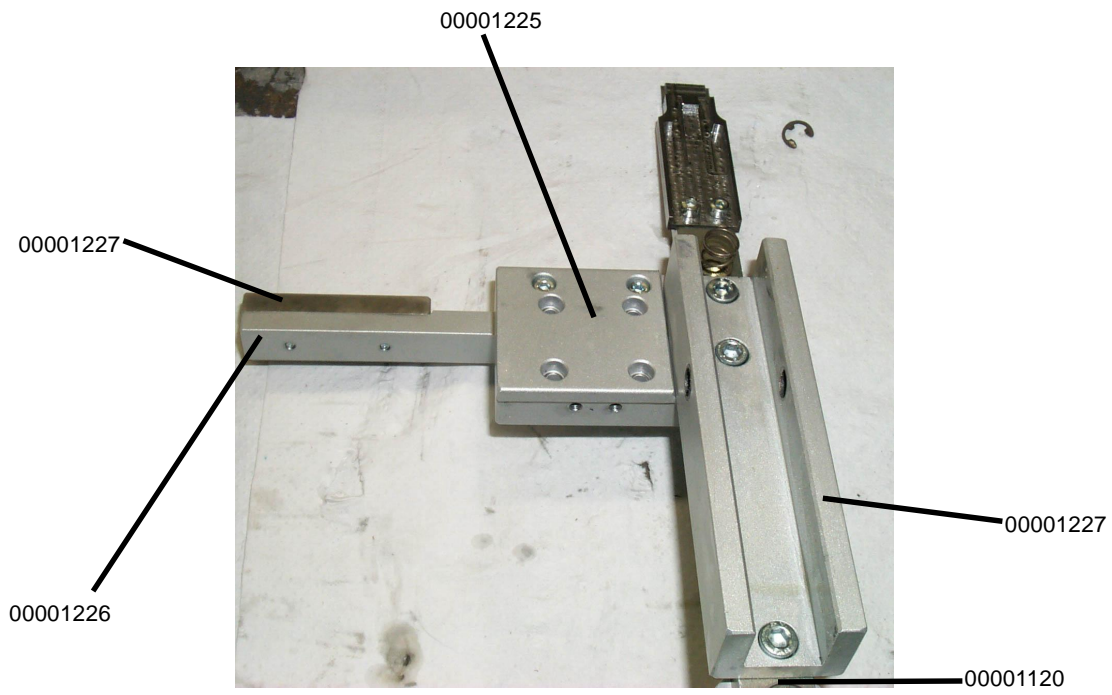

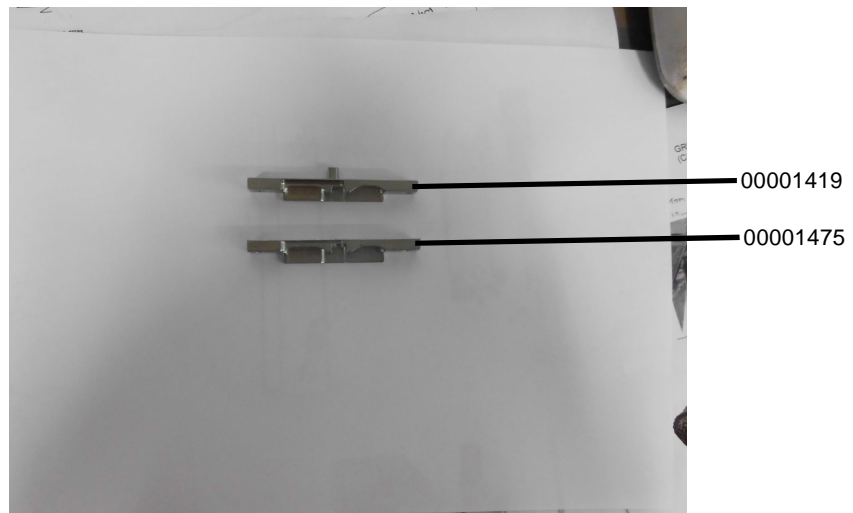
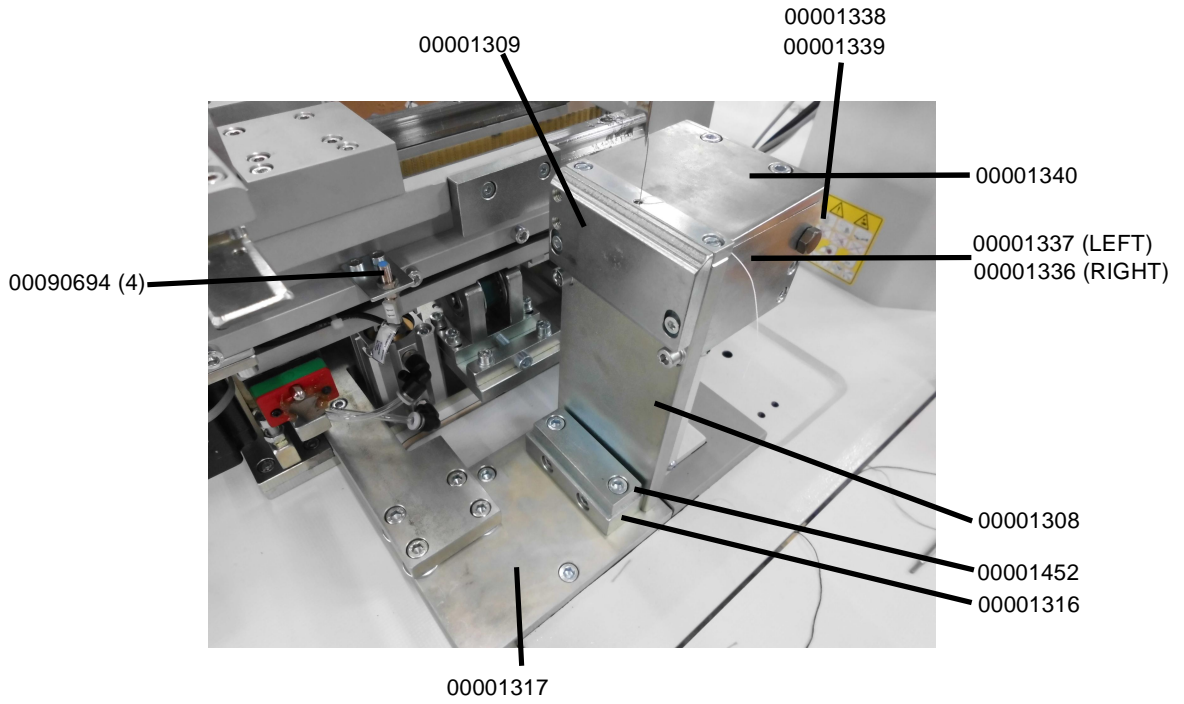

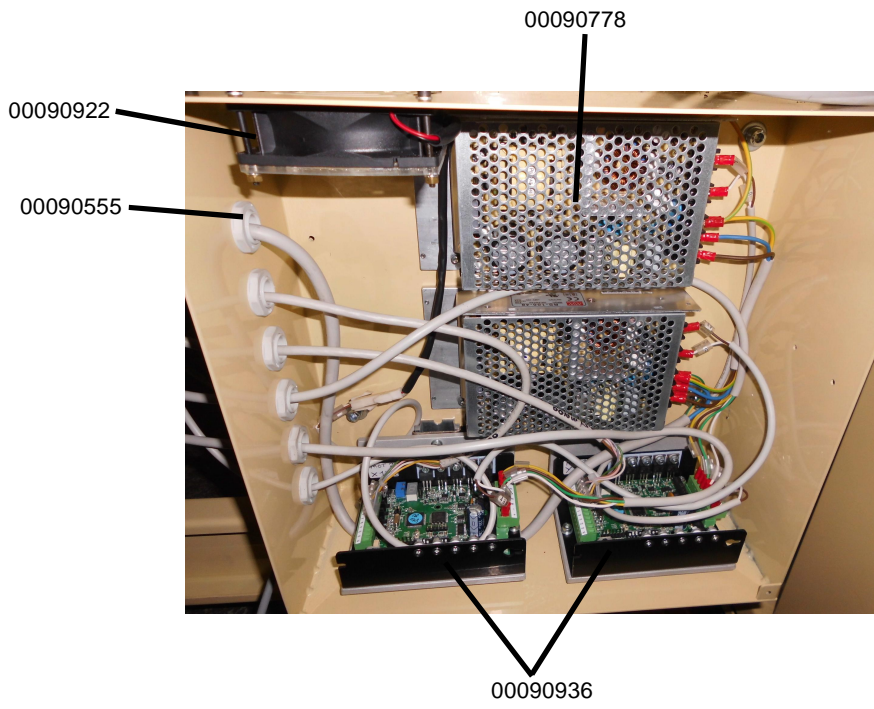
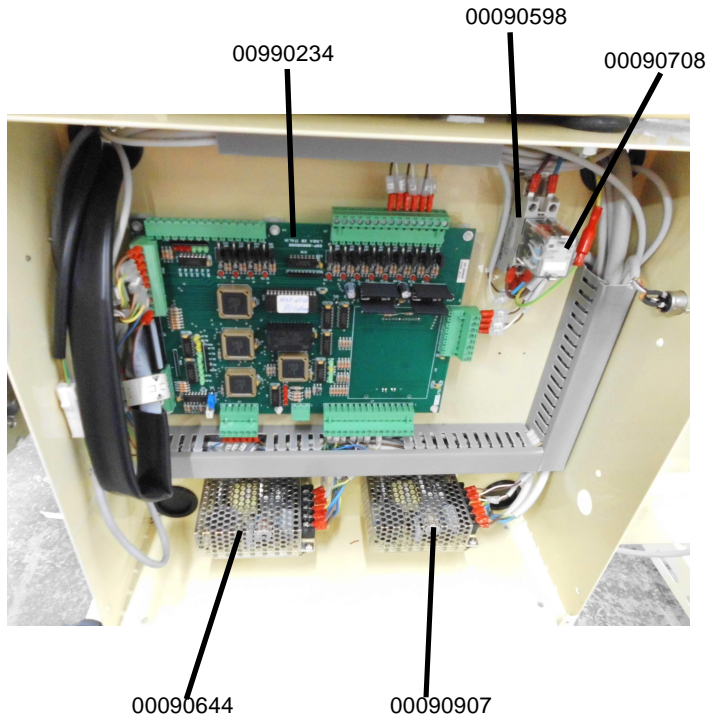

00090942

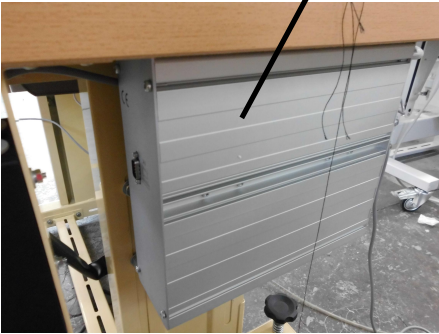

00090645

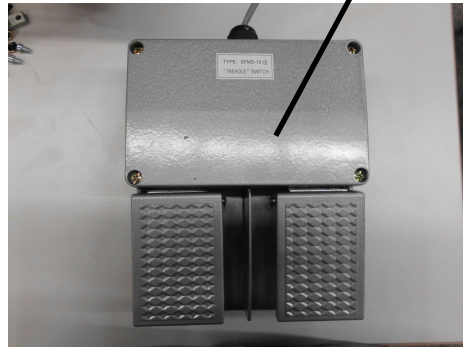

00090770

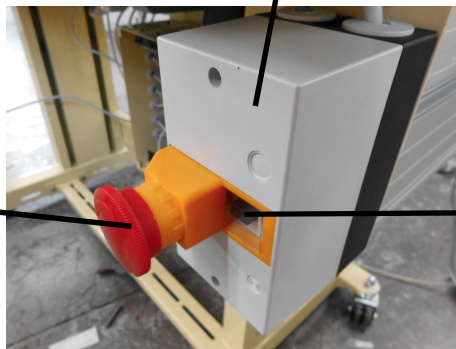

00090771

000909769

000909669



00990272 (COMPLETE)
00090891 (ONLY COVER)

00050036

00050133

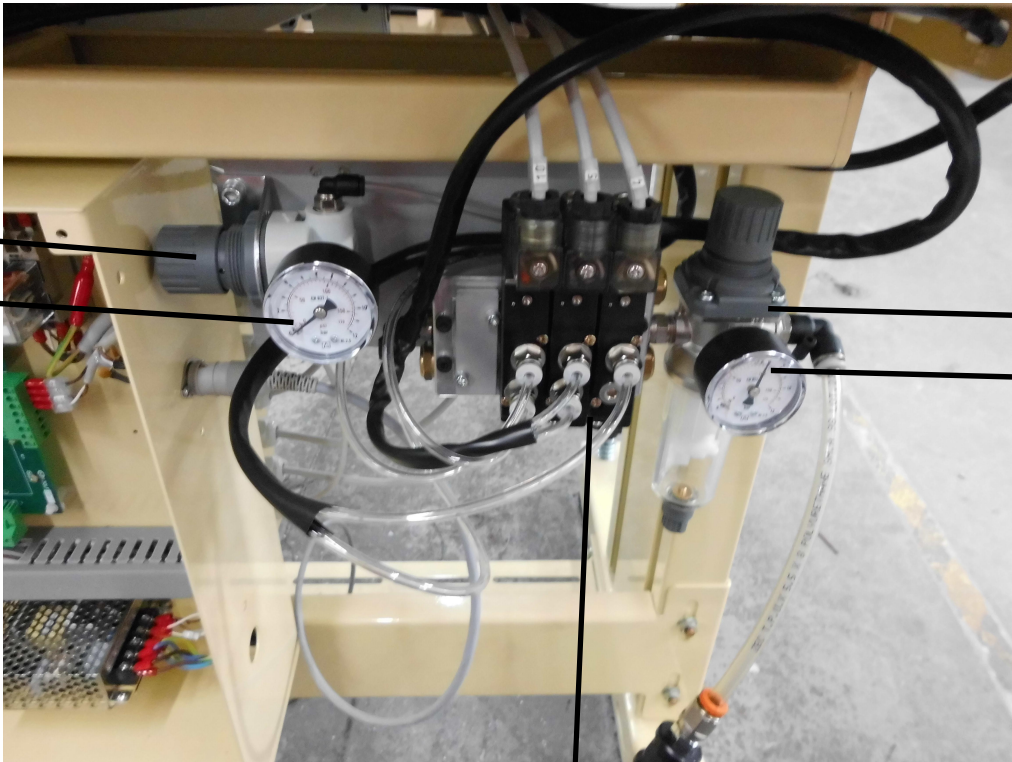

00050364

00050133

00050422 (3)