

S-7180A

INSTRUCTION MANUAL

Please read this manual before using the machine.
Please keep this manual within easy reach for quick reference.

SINGLE NEEDLE DIRECT DRIVE LOCK STITCHER
WITH THREAD TRIMMER, ELECTRIC FEEDING
SYSTEM AND PRESSER FOOT LIFTER

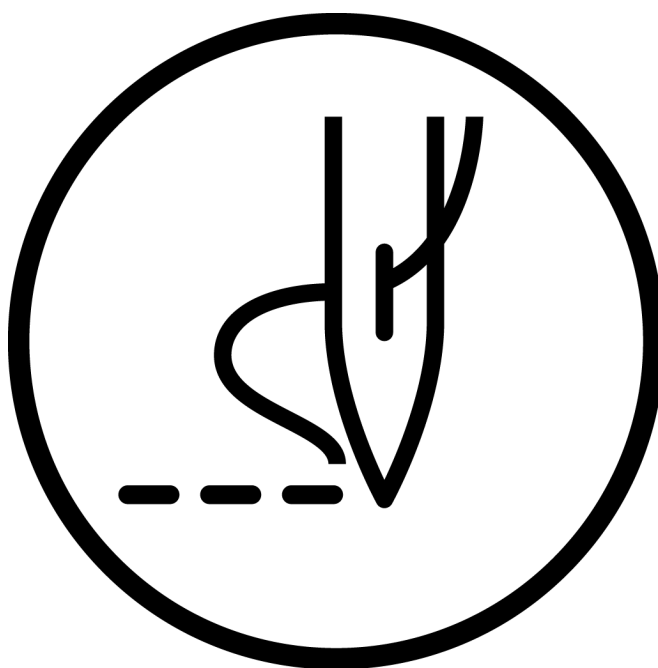

brother

Thank you very much for buying a BROTHER sewing machine. Before using your new machine, please read the safety instructions and the explanations given in the instruction manual. With industrial sewing machines, it is normal to carry out work while positioned directly in front of moving parts such as the needle and thread take-up, and consequently there is always a danger of injury that can be caused by these parts. Follow the instructions from training personnel and instructors regarding safe and correct operation before operating the machine so that you will know how to use it correctly.



SAFETY INSTRUCTIONS

[1] Safety indications and their meaning

The symbols used in this instruction manual and on the product are intended to ensure safe and correct use of the product and to prevent harm to the user and other persons as well as damage to the product.

Its display and meaning are as follows.

Indications

 DANGER	Failure to abide by the information in a warning may result in serious injury and can be life threatening.
 Warning	Indicates a potentially hazardous situation which, if ignored, could result in death or serious injury.
 Note	Indicates a potentially hazardous situation which, if ignored, could result in minor or moderate injury.

Symbols



.....

The symbol means "what you should be aware of." 

The illustrations in this symbol indicate the contents of caution.
(In the example on the left, be careful not to injure yourself.)



.....

The symbol means "Do not do it". 



.....

Symbol means "Must do." 

The illustrations in this symbol represent the contents of the instructions.
(In the example on the left, ground connection shall be made.)

[2] Notes on safety

DANGER



When opening the cover of the control box, be sure to turn off the power switch, unplug the power cord, wait for 5 minutes, and then open the cover. Touching high voltage parts may cause serious injuries.

WARNING



Do not wet the machine with liquid.

Fire, electric shock or malfunction may occur.



In the unlikely event that liquid enters the machine (sewing machine head/control box), immediately turn off the power switch, unplug it, and contact your dealer or a trained technician.

CAUTION

Environmental requirements



Use the product in an environment that is not affected by strong electrical noise, such as power line noise or static electricity noise. Strong electrical noise may cause malfunction of the sewing machine.



Use the product in an environment where the fluctuation of the power supply voltage is within $\pm 10\%$ of the rated voltage. Large voltage fluctuations may cause malfunction of the sewing machine.



Use the product in an environment where the power supply capacity is more than the power consumption of the product. Insufficient power supply capacity may cause malfunction of the sewing machine.



The ambient temperature should be between 5°C and 35°C. Low or high temperatures may cause the machine to malfunction.



The relative humidity should be within the range 45% to 85% during use, and should be used in a non-condensing environment. Drying, high humidity, or condensation on the device may cause the machine to malfunction.



Turn off the power and unplug the power cord during a lightning storm. Lightning can cause the machine to malfunction.



Do not connect any media other than USB media to the USB port. This may cause damage.

Installation



The machine may only be installed by trained personnel.



Have electrical wiring done by your dealer or an electrician.



The sewing machine weighs approximately 37kg. Install the product by two or more persons.



Do not connect the power plug until installation is complete.

If the treadle is depressed by mistake, the sewing machine may operate and cause injury.



Turn off the power switch before inserting or removing the plug. Doing so may cause the control box to malfunction.



Please connect to the Earth. Incomplete ground connection may cause electric shock or malfunction.



When fixing the cord, do not forcibly bend the cord or press it too much with a staple.



This may cause a fire and electrical shock.



For the table with casters, fix the casters so that they do not move.



When tilting the sewing machine head, fix it so that the table does not move. Movement of the table may cause injuries such as pinching the foot.



Use both hands to tilt or pull back the machine. If you do so with one hand, your hand may slip due to the weight of the sewing machine and cause injuries such as injuries.















When handling lubricating oil or grease, use protective goggles or gloves to avoid contact with your eyes or skin. Doing so may cause irritation.





Do not swallow or eat lubricating oil or grease. Diarrhea and vomiting may occur. Keep it out of the reach of children.

CAUTION











Sewing

- | | |
|---|---|
|  This machine may only be used by trained personnel for safe operation. |  Do not touch or press against moving parts during sewing.
Failure to do so may result in injury or damage to the machine. |
|  Do not use this sewing machine for purposes other than as a sewing machine. |  When tilting the sewing machine head, fix it so that the table does not move.
Movement of the table may cause injuries such as pinching the foot. |
|  Use protective goggles when operating the machine.
A broken needle may get into your eyes and cause injury. |  Use both hands to tilt or pull back the machine.
If you do so with one hand, your hand may slip due to the weight of the sewing machine and cause injuries such as injuries. |
|  Turn off the power switch in the following cases.
If the treadle is depressed by mistake, the sewing machine may operate and cause injury. |  If you notice any malfunction or unusual noise or smell during use, turn off the power switch immediately. Then contact your dealer or a trained technician. |
|  · Threading
· Replacing the bobbin or needle
· When not using the machine or leaving the machine unattended |  If the machine malfunctions, contact your dealer or a trained technician. |
|  For the table with casters, fix the casters so that they do not move. | |
|  Install and use protective equipment for safety.
Using the product with these devices removed may result in injury. | |

Care

- | | |
|---|---|
|  Turn off the power switch before starting work.
If the treadle is depressed by mistake, the sewing machine may operate and cause injury. |  When handling lubricating oil or grease, use protective goggles or gloves to avoid contact with your eyes or skin. Doing so may cause irritation.
Do not swallow or eat lubricating oil or grease. Diarrhea and vomiting may occur.
Keep it out of the reach of children. |
|  When tilting the sewing machine head, fix it so that the table does not move.
Movement of the table may cause injuries such as pinching the foot. | |
|  Use both hands to tilt or pull back the machine.
If you do so with one hand, your hand may slip due to the weight of the sewing machine and cause injuries such as injuries. | |

Maintenance and inspection

- | | |
|---|---|
|  The machine must be serviced by a trained technician. |  When tilting the sewing machine head, fix it so that the table does not move.
Movement of the table may cause injuries such as pinching the foot. |
|  Have electrical maintenance and inspection performed by your dealer or an electrician. |  Use both hands to tilt or pull back the machine.
If you do so with one hand, your hand may slip due to the weight of the sewing machine and cause injuries such as injuries. |
|  Turn off the power switch and unplug the power cord in the following cases:
If the treadle is depressed by mistake, the sewing machine may operate and cause injury. |  When replacing parts or installing optional parts, use our genuine parts.
We are not responsible for accidents or failures caused by the use of non-genuine parts. |
|  · Inspection, adjustment or repair
· Replacement of consumable parts such as a hook and knife |  If the safety guard is removed, be sure to install it in its original position and check that it functions properly. |
|  When opening the motor cover, be sure to turn off the power switch, and then wait for one minute before opening the cover.
Touching the motor surface may cause burns. | |
|  If you need to make adjustments while the power switch is turned on, use extreme safety precautions. | |

Modification

- | | |
|---|--|
|  To prevent accidents and malfunctions, do not modify the sewing machine (including the control unit).
We are not responsible for accidents or failures caused by modification. | |
|---|--|

[3] Warning labels

The warning labels shown below are displayed on the sewing machine.

Be sure to observe the precautions on the warning labels.

Also, if the label is peeled off or becomes unreadable, contact the retailer from whom the watch was purchased.

1



3



Be careful not to pinch your hands when returning the overturned sewing machine head.

4



Be careful not to injure yourself with a moving thread take-up.

2

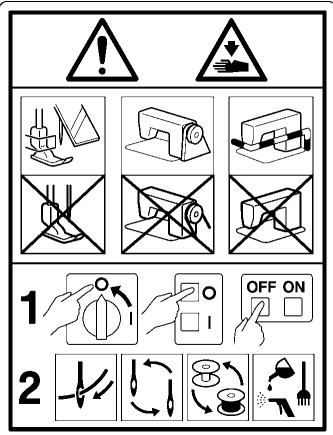

CAUTION
Moving part may cause injury.

Operate with safety devices* installed.

Turn off the power before carrying out operations such as threading, changing the needle, bobbin, knives or hook, cleaning and adjusting.

5



High temperature caution display

6



Please connect to the Earth. Incomplete ground connection may cause electric shock or malfunction.

7



Display of rotation direction

* Safety protection device:
(A)Finger guard
(B)Balance cover
(C) Motor cover

8

brother

机械润滑油
Lubricating Oil for Machining



注意

润滑油可能会引起眼睛发炎。
吞食润滑油会引起腹泻和呕吐。请勿吞食。

接触眼睛时：
- 请用冷水冲洗。
- 寻求医疗救助。
如果不慎吞食：
- 请立即寻求医疗救助。

CAUTION

Oil may cause inflammation to eye.
Swallowing oil can cause diarrhoea and vomiting. Do not swallow.

Eye contact:
-Rinse with plenty of cold water.
-Seek medical help.
IF swallowed:
-Seek medical help immediately.

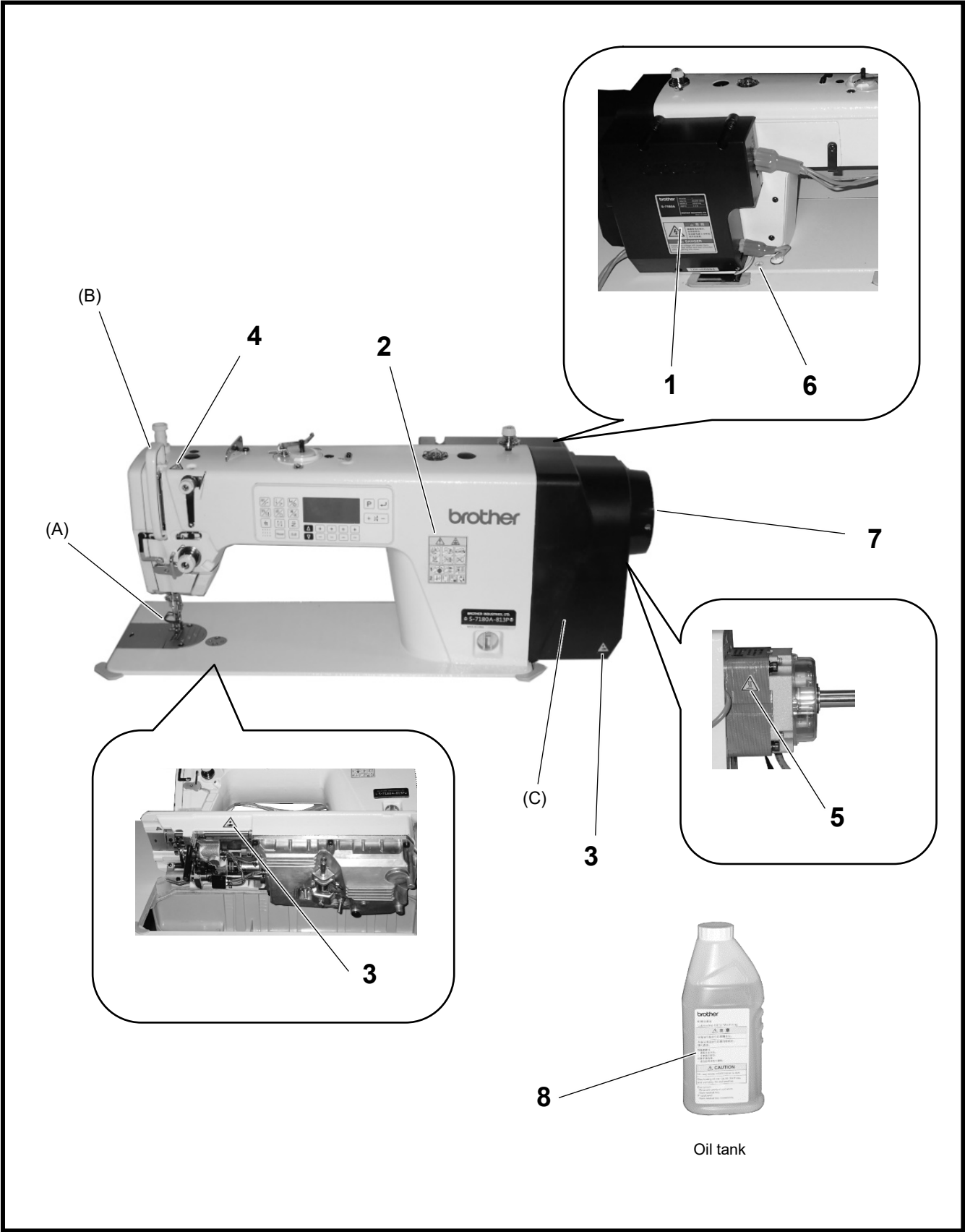

CONTENTS

1. Specifications of the sewing machine.....	1
2. Installation	2
2-1. Table drawing.....	3
2-2. How to install.....	3
2-3. Lubrication method.....	6
2-4. Connecting the cord	7
2-4-1. Connecting the cord	7
3. Operation panel.....	8
3-1. Name and Function.....	8
3-1-1. Key name and function	8
3-1-2. Icon function	10
3-2. How to set the memory switch.....	12
3-2-1. Memory switch setting mode for operator	12
3-2-2. Memory switch setting mode for Mechanic	13
3-3. How to set the sewing pattern.....	15
3-3-1. Normal sewing.....	15
3-3-2. Fixed stitch	16
3-3-3. Continuous fixed stitching	17
3-3-4. Step sewing.....	19
3-3-4-1. Step sewing setting.....	19
3-3-4-2. Step edit mode.....	20
3-3-5. Step stitching with arbitrary pitch.....	22
3-3-5-1. Step sewing setting of arbitrary pitch	22
3-3-5-2. Step edit mode with arbitrary pitch (number of stitches)	23
3-3-5-3. Step edit mode with arbitrary pitch	24
3-4. How to set the sewing speed	25
3-5. How to set the front start and end backtack stitches.....	26
3-6. How to set up condensation sewing	27
3-6-1. Additional setting of condensation sewing	27
3-6-2. Condense edit mode	28
3-7. How to set the main part design stitch.....	29
3-7-1. Design stitching of main section	29
3-7-2. Design stitch of the main part Edit mode	30
3-8. How to set the stitch for the sewing stop design	32
3-8-1. Design stitching of sewing stops.....	32
3-8-2. Design stitch editing mode for sewing stops.....	33
3-9. Checking method of the production counter..	35
3-10. How to set up the handy switch.....	35
3-11. How to confirm the software version	35
3-12. How to set head specifications	35
3-13. Data initialization method	36
3-14. Memory Switch	37
3-15. List of Error Codes.....	49
3-16. About USB.....	53
4. Cleaning	54
5. Standard adjustment.....	55
5-1. Arm thread guide R	55
5-2. Height of presser foot	56
5-3. Feed dog height.....	57
5-4. Inclination of the feed dog	57
5-5. Height of the needle bar	58
5-6. Timing of needle and feed	58
5-7. Timing of the needle and the hook	59
5-8. Adjusting the amount of oil supply to the hook	60
5-9. Adjusting the Upper Shaft Lubrication Amount	61
5-10. Thread trimmer	62
6. In the following cases	65
6-1. Sewing-related.....	65

1. Specifications of the sewing machine

S-7180A-81  P

Applications	
3	For medium
5	Thick material

	-813P	-815P
Maximum sewing	5,000sti/min	4,000sti/min
Backtack sewing speed	3,200sti/min	
Max. stitch length	5mm	5mm*
Thread trimming method	Double action thread trimming mechanism	
Thread holder	Standard equipment	
Handy switch	Standard equipment	
LED light	Standard equipment	
Solenoid press lift	Standard equipment	
Height of presser foot	Knee lift: 10 to 15 mm/Automatic: 12 mm	
Needle to be used (DB×1/DP×5)	#11-#18	#19-#22
Feed dog height	0.9mm	1.2mm
Motor	AC servo motor	
Weight	37kg	
Power supply	Single-phase: 200 to 240V Maximum power consumption: 400 VA	

*If you need 7mm specification, please contact our sales representative.

2. Installation



CAUTION



The machine may only be installed by trained personnel.



Have electrical wiring done by your dealer or an electrician.



The sewing machine weighs approximately 37kg. Install the product by two or more persons.



Do not connect the power plug until installation is complete.

If the treadle is depressed by mistake, the sewing machine may operate and cause injury.



When tilting the sewing machine head, fix it so that the table does not move.

Movement of the table may cause injuries such as pinching the foot.



Use both hands to tilt or pull back the machine.

If you do so with one hand, your hand may slip due to the weight of the sewing machine and cause injuries such as injuries.

Location of the sewing machine

- Do not install this equipment near a TV, radio or cordless phone. Noise may enter the TV, radio or cordless phone.
- Install this unit in a location where the power can be directly removed from the AC outlet. Use of an extension cord may cause malfunction of the sewing machine.

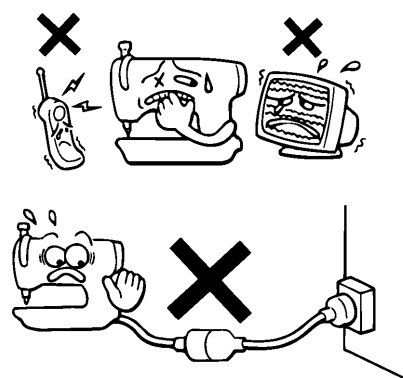

How to carry the sewing machine

- Hold the arm body and motor cover as shown in the figure and carry the sewing machine by two persons.
- * Do not hold other than the motor cover. Doing so may damage the sewing machine.

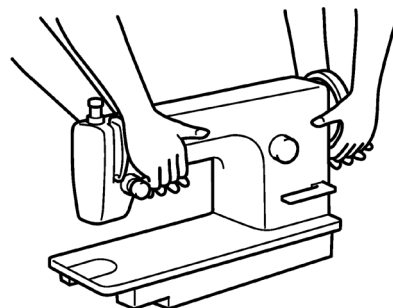

Tilting the sewing machine head

- Hold the (A) part with your foot so that the table does not move, and push the arm body with both hands to tilt the sewing machine head.

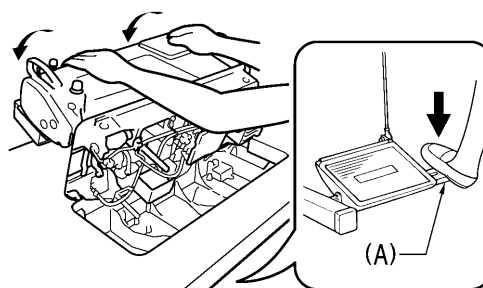

How to return the sewing machine

- Place a tool, etc., from near the table hole.
- Slowly return the sewing machine head with your right hand while holding the face plate part with your left hand.

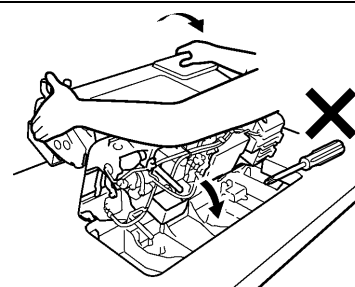

2. How to install

2-1. Table drawing

- The table should be 40mm thick and strong enough to accommodate the weight and vibration of the sewing machine.
- Drill holes as shown in the illustration.

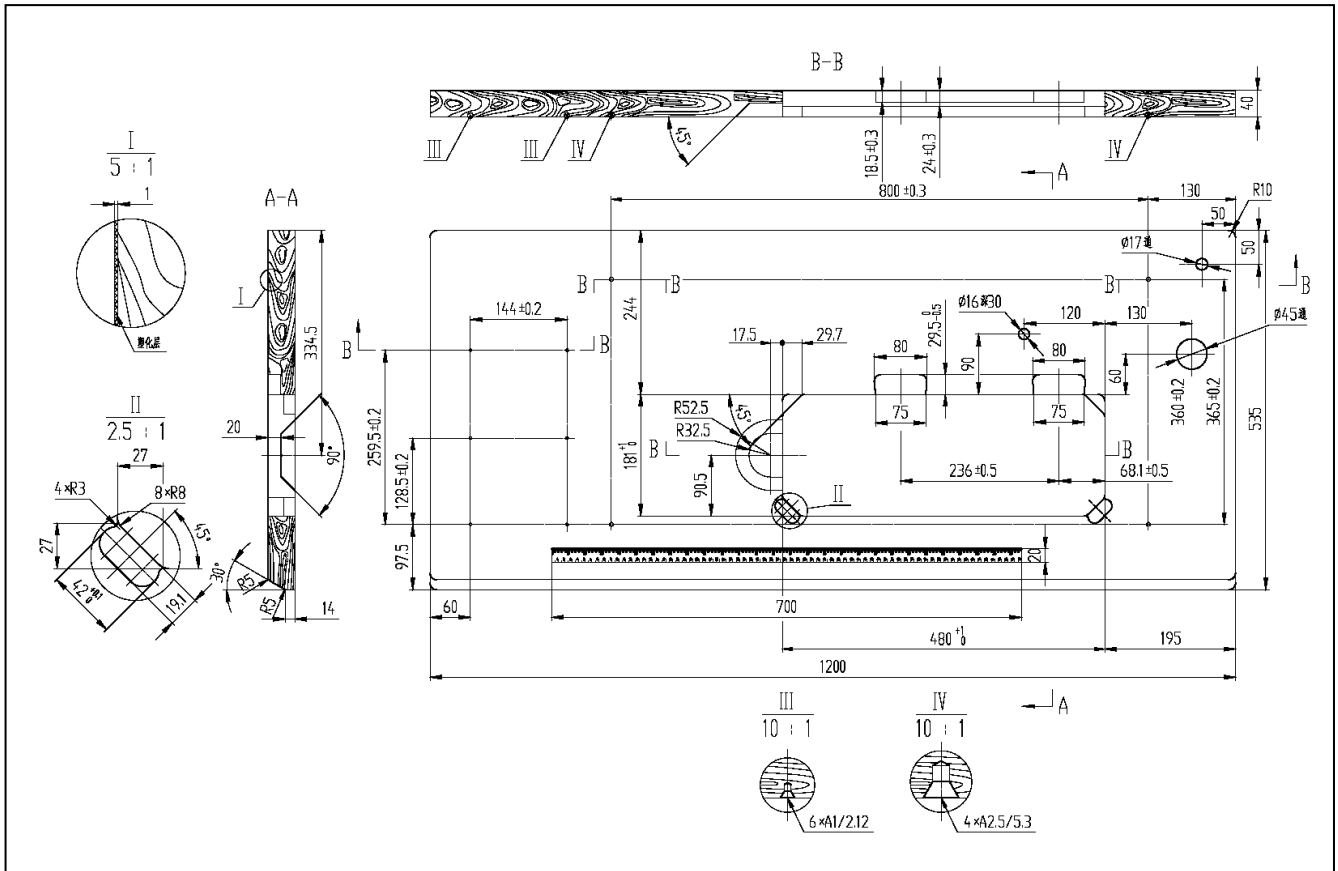

2-2. How to install

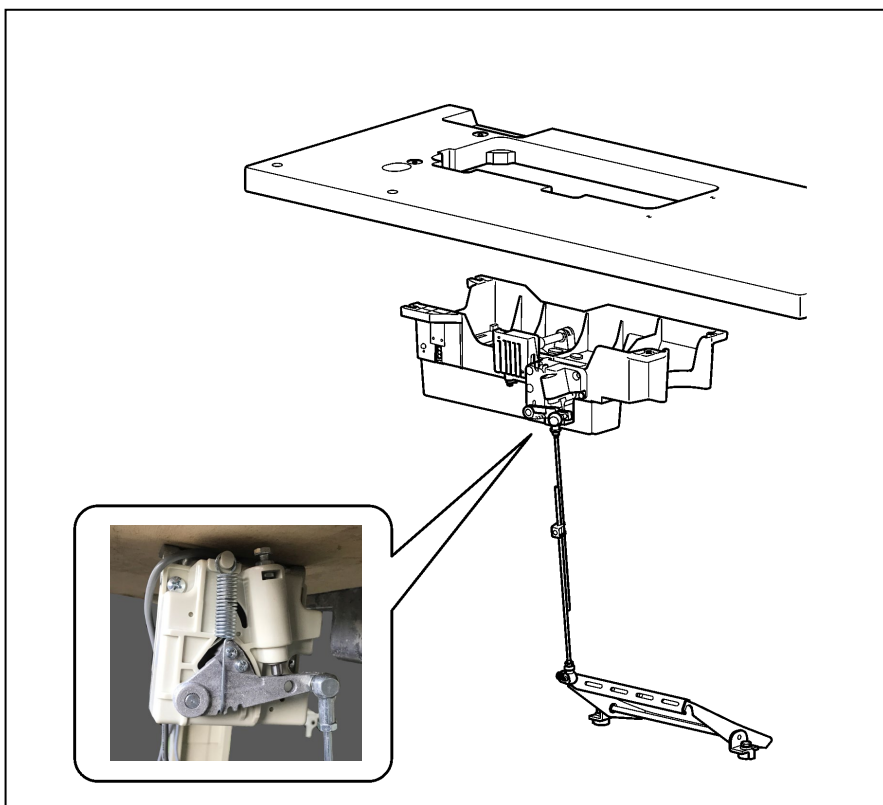

1. Connecting rod

- (1) Connecting rod
- (2) Nut



2. Oil pan

Tighten the oil pan with wood screws from below.

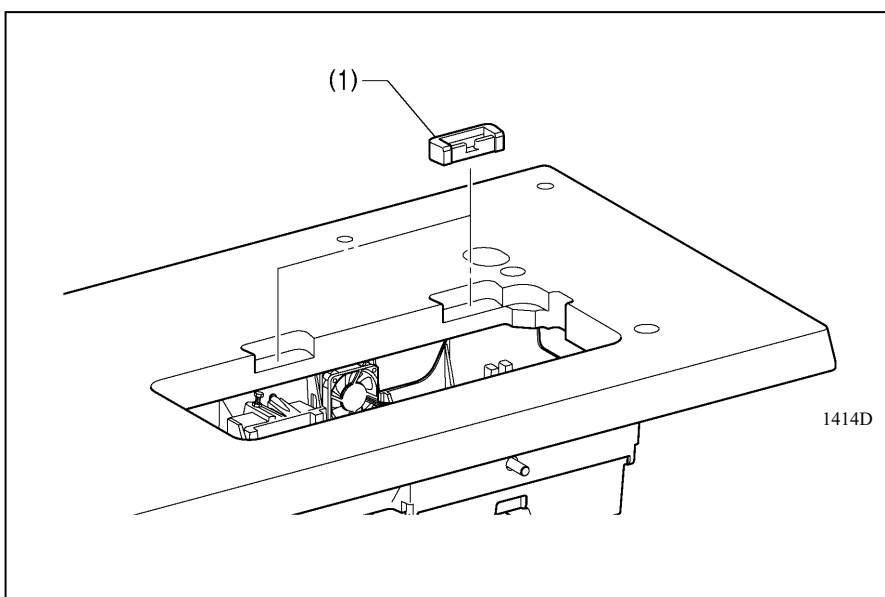

3. Head hinge receiving rubber

(1) Head hinge receiving rubber [2 pcs]

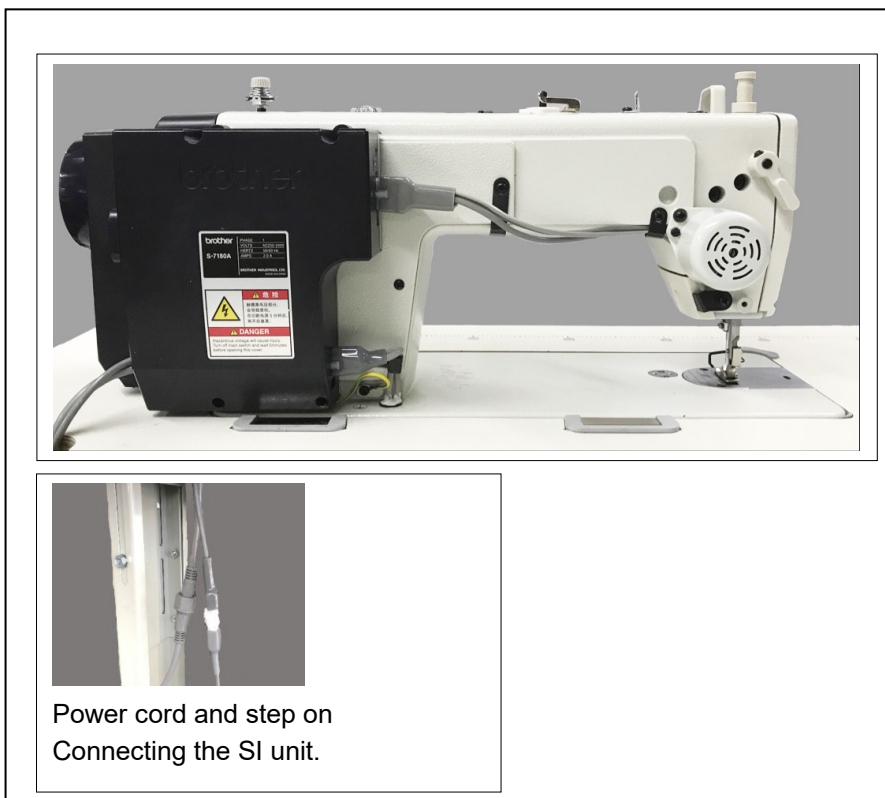

4. Sewing machine head

- (1) Hinge [2 pcs]
- (2) Sewing machine head
- (3) Pillow

[Note]

- Bundle the cords and route them through the cord holes.
- Place the pillow (3) firmly into the table as far as it will go.
- If it is not inserted to the end, it is dangerous because of poor stability when the sewing machine head is tilted.

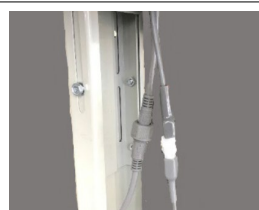

Power cord and step on
Connecting the SI unit.

2. How to install

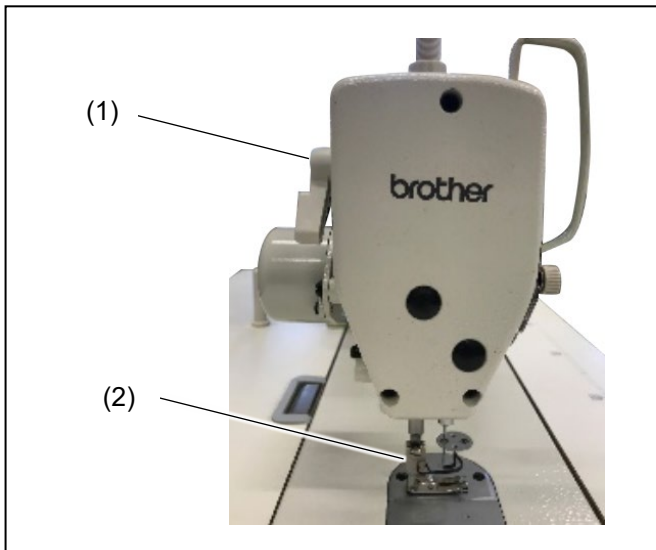

5. Knee pad

<Adjusting knee lifting>

1. Turn the pulley to lower the feed dog from the top of the needle plate.
2. Lower the presser foot (2) with the presser foot lifter (1).

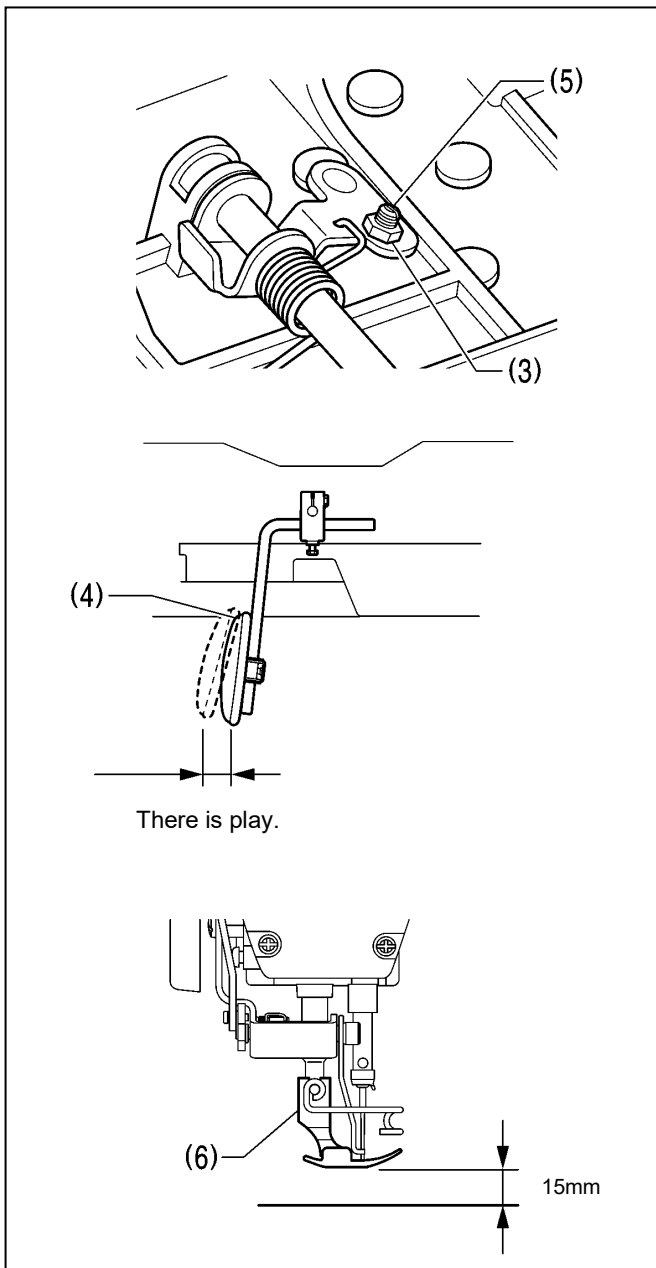



3. Loosen the nut (3).
4. Adjust by turning the screw (5) so that there is a movement amount (backlash) of the knee pad (4).
5. After this adjustment is made, tighten the nut (3) firmly.

6. Adjust so that the presser foot (7) is within 15mm of the needle plate when the knee pad is pressed fully.

2-3. Lubrication method

 **CAUTION**

-  Do not connect the power plug until lubrication is complete.
If the treadle is depressed by mistake, the sewing machine may operate and cause injury.
-  When handling the lubricant, use protective goggles or gloves to avoid contact with your eyes or skin.
Doing so may cause irritation.
Do not drink lubricating oil. Diarrhea and vomiting may occur.
Keep it out of the reach of children.
-  Hold the base of the nozzle firmly when cutting the nozzle of the oil tank.
Holding the nozzle by its tip may cause injury by scissors.

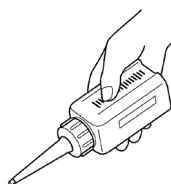

Be sure to lubricate the machine when using it for the first time or when it has not been used for a long time.

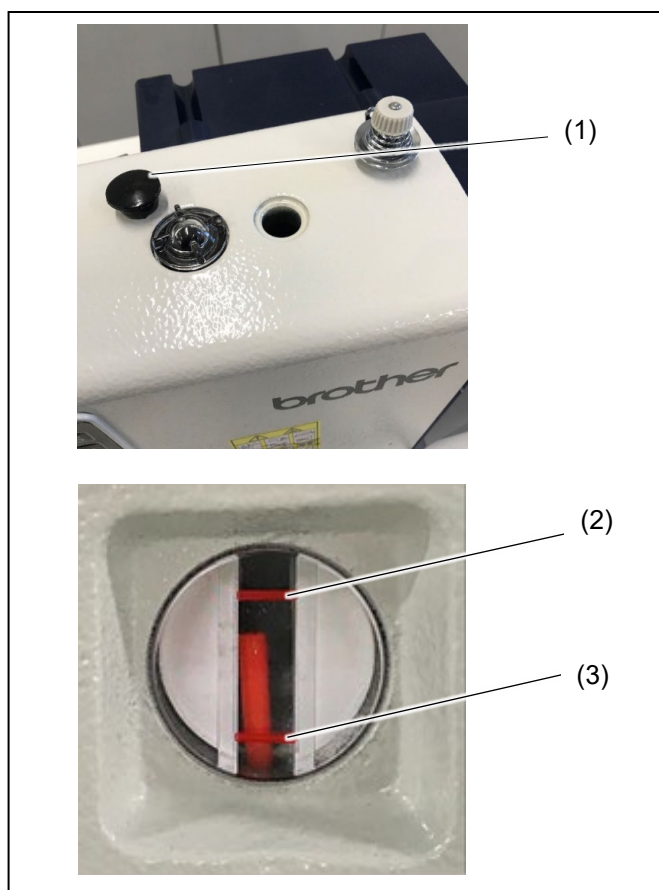

1. Remove the rubber stopper (1) and pour lubricant to the upper baseline (2) of the oil window.
2. Close the rubber stopper (1).

[Note]

In the following cases, the oil lubricant may leak if the sewing machine head is tilted.





- 1) When lubricating oil is filled above the baseline (2) above the oil window.

<When to Supply Lubricant>

When the oil level drops below the baseline (3) in the oil window, be sure to supply oil.

2-4. Connecting the cord

CAUTION

-  Have electrical wiring done by your dealer or an electrician.
-  Do not connect the power plug until the connection of the cord is complete.
If the treadle is depressed by mistake, the sewing machine may operate and cause injury.
-  When fixing the cord, do not forcibly bend the cord or press it too much with a staple.
This may cause a fire and electrical shock.
-  Please connect to the Earth.
Incomplete ground connection may cause electric shock or malfunction.

2-4-1. Connecting the cord



Connecting the Power Cord and Step Unit

1. Code

- (1) Power cord
- (2) Tread unit



2. Ground wire

- (1) Ground wire
- (2) Tightening screw

[Note]









- For safety, be sure to connect the ground wire securely.

3. Operation panel









3-1. Name and Function

3-1-1. Key name and function

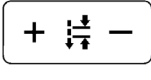

Name	Key	Function
Memory switch key		Click this button to enter the memory switch setting mode for the operator. Touch and hold to display the password entry screen. Now enter the correct password and press the key to enter the mechanic memory switch setting mode. 
Enter key		Click to confirm the changed value or move to the lower (upper) mode. Press and hold to enter adjustment mode.
Plus key		Click to increase the corresponding value. Press and hold to continuously increase the corresponding value.
Minus key		Click to decrease the corresponding value. Press and hold to continuously decrease the corresponding value.
Reset button		Press and hold to return to the factory default settings.
Pre-stop sewing/slow start key		Click to switch the pre-stop stitching operation in the following order. AB → ABAB → none → B → .. Press and hold to toggle the slow start function (yes/no).
Post-stop sewing/needle up/down key		Click to switch the stop stitching operation in the following order. CD → CD → none → C → .. Press and hold to switch the needle stop position (needle up/needle down) after sewing.
Normal sewing/needle up/down key		Click to set the sewing pattern to normal sewing. Press and hold to set the sewing pattern to fixed sewing.

3. Operation panel



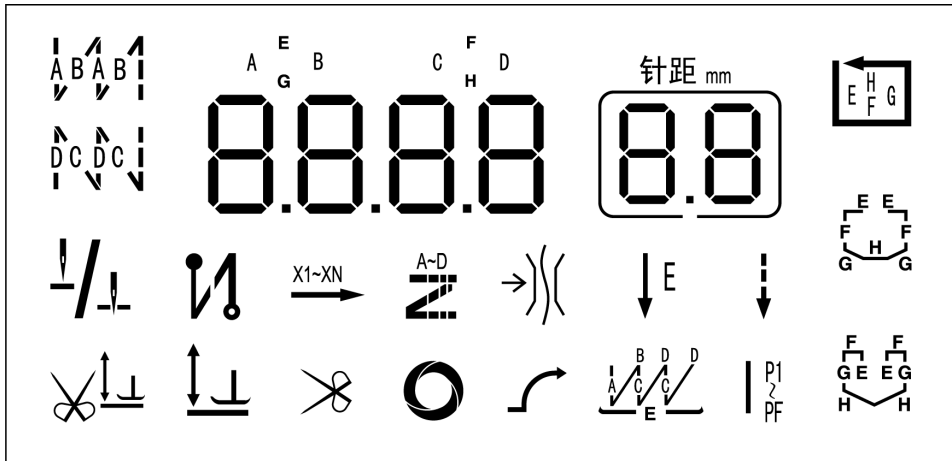

Name	Key	Function
Continuous sewing/step sewing key		Click to set the sewing pattern to continuous stop sewing. Press and hold to set the sewing pattern as a step sewing with a common pitch. The sewing pattern is switched in the order shown below. 15-step sewing → 4-step sewing → 7-step sewing → 8-step sewing → 15-step sewing →..
Presser foot lift/Auto key		Click to switch the presser foot lifting operation in the order shown below. In → the presser foot is not raised automatically (the presser foot is raised by pedaling) → for raising the presser foot after cutting the thread → for raising the presser foot immediately after the upper shaft stops → to raise the presser foot after cutting the thread and immediately after the upper shaft has stopped.. Press and hold to toggle the automatic sewing function (enable/disable). *Valid only for inching, design stitching, and step stitching
Thread trimmer/thread holder key		Click to switch the thread trimming function (yes/no). Press and hold to thread hold function (yes/no).
Main part design stitch key		Click this button to switch the design stitch function (enable/disable) of the main part. Press and hold to enter the design stitch editing mode in the main section.
Condensation seam key		Click to switch the condensation sewing function in the order shown below. Beginning sewing condensation sewing → Final sewing condensation sewing → First stitch End sewing condensation sewing → No condensation sewing →.. Press and hold to enter the condensation editing mode.
Stitch key for sewing stop design		Click to toggle the design stitch function (enabled/disabled) for the stop sewing part. Press and hold to enter the design stitch editing mode for the stop stitch.
Step sewing key with arbitrary pitch		When clicked, the sewing pattern is a step sewing with an arbitrary pitch. Press and hold to enter the desired pitch editing mode for step sewing. *Valid only when sewing pattern is step sewing (arbitrary/common)
Pitch key		Click to increase or decrease the pitch. Press and hold to continuously increase or decrease the pitch.
Acceleration key		Click to increase the sewing speed. Press and hold to increase sewing speed continuously.
Deceleration key		Click to decrease the sewing speed. Press and hold to continuously reduce the sewing speed.

3-1-2. Icon function



Icon	Function
	Indicates the start backtack (none/B/AB/ABAB).
	Indicates the end backtack (none/C/CD/CDCD).
	Indicates the needle stop position (up/down).
	Indicates whether there is condensation sewing (no sewing/start sewing/end sewing/start sewing and end sewing).
	Lights when the pitch of the step sewing is set to a desired pitch.
	Illuminates when the sewing stop is design stitched.
	Lights up when the thread holder at the start of sewing.
	Lights when the feeding frame lifting operation is available after cutting the thread.
	Lights up when the feeding frame lifting operation is present immediately after the upper shaft stops.
	Lights when the thread cutting function is enabled.
	Lights when the automatic sewing function is enabled.
	Lights when the slow start function is enabled.
	Lights when the fixed sewing.
	Lights when the sewing pattern is normal sewing.

3. Operation panel

Icon	Function
	Lights when the sewing pattern is continuous backtack sewing.
	Lights up when the sewing pattern consists of up to 15 steps.
	Lights up when the sewing pattern is a step sewing consisting of 4 steps.
	Lights up when the sewing pattern is a step sewing consisting of 7 steps.
	Lights up when the sewing pattern consists of 8 steps.

3-2. How to set the memory switch

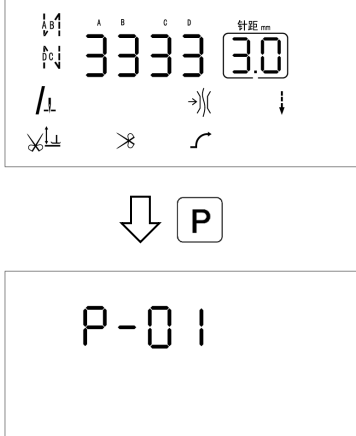
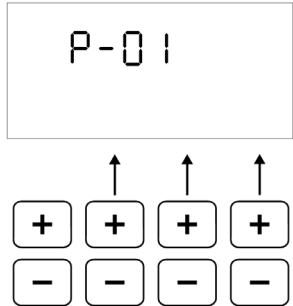
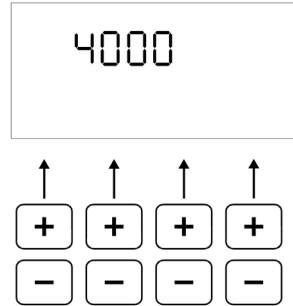

- The memory switch can be set for the operator or the mechanism.

3-2-1. Memory switch setting mode for operator

1	<p>Entering the Memory Switch Setting Mode for Operators</p> 	<p>Press the key on the home screen to switch to the memory switch setting mode for the operator. P</p>
2	<p>Memory Switch Selecting a Number</p> 	<p>Press the keys in the second to fourth columns to select the memory switch number (P01 to P43). + -</p> <p>Then press the key to display the setting value of the corresponding memory switch number. ↵</p>
3	<p>To change a set value</p> 	<p>Use the keys in the first to fourth columns to change the setting value. + -</p>
4	<p>Setting Confirmation</p>	<p>When the setting is completed, press the key to confirm the value. ↵</p> <p>[Precaution] If the key is pressed without pressing the key, the set value is not confirmed. ↵ P</p>
5	<p>Exiting Operator Memory Switch Setting Mode</p>	<p>To exit the memory switch setting mode for the operator and return to the home screen, press the key. P</p>

3. Operation panel

3-2-2. Memory switch setting mode for Mechanic

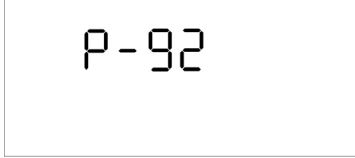
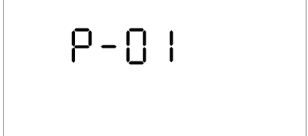
<p>1</p>	<p>Switch to mechanic memory switch setting mode</p>  <p>↓ P Press and hold</p>  <p>↑ ↑ ↑ ↑ + + + + - - - - ↓ ↵</p> 	<p>Press and hold the key on the home screen to switch to the password entry screen. P</p> <p>Use the keys in the first to fourth columns to enter the password, + - ↵ Press the key. *The password is "8888".</p> <p>When the password is entered correctly, the unit switches to the mechanic memory switch setting mode.</p>
<p>2</p>	<p>Memory Switch Selecting a Number</p>  <p>↑ ↑ ↑ + + + + - - - -</p>	<p>Use the keys in the second to fourth columns to select the memory switch number (P01 to P256). + - Then press the key to display the setting value of the corresponding memory switch number. ↵</p>

3	<p>To change a set value</p> <p>Use the keys in the first to fourth columns to change the setting value.</p> <div data-bbox="236 203 517 338" style="border: 1px solid black; padding: 5px; text-align: center; font-size: 24px;">4000</div> <div data-bbox="692 212 804 255" style="display: inline-block; margin-right: 20px;">+ -</div> <div data-bbox="236 356 504 506" style="display: flex; flex-direction: column; align-items: center;"><div style="display: flex; justify-content: space-around; width: 100%;">↑↑↑↑</div><div style="display: flex; justify-content: space-around; width: 100%;">++++</div><div style="display: flex; justify-content: space-around; width: 100%;">----</div></div>
4	<p>Setting Confirmation</p> <p>When the setting is completed, press the key to confirm the value. ↵</p> <p>[Precaution] If the key is pressed without pressing the key, the set value is not confirmed. ↵ P</p>
5	<p>Exiting the mechanic memory switch setting mode</p> <p>To exit the mechanic memory switch setting mode and return to the home screen, press the key. P</p>





3. Operation panel

3-3. How to set the sewing pattern

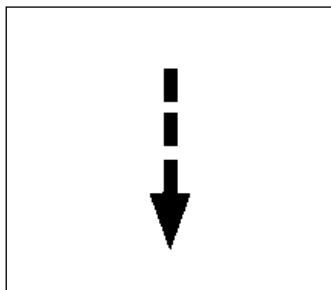
There are five sewing patterns: normal sewing, inching sewing, continuous stop sewing, step sewing with common pitch, and step sewing with arbitrary pitch.





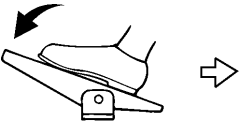



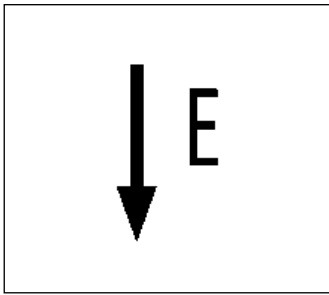

3-3-1. Normal sewing

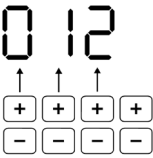

1	<p>Normal sewing setting</p> 	 Press the key so that the icon lights. 
2	<p>Normal sewing pitch setting</p> 	<p>The pitch of the normal sewing is set with the key. </p>
3	<p>Setting the normal sewing speed</p>	<p>The normal sewing speed is set with P01 on the memory switch.</p>
4		<p>Sewing is performed while the treadle is held down.</p>

3-3-2. Fixed stitch



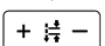
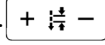
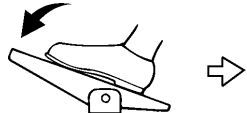

<p>1</p>	<p>Setting of inching sewing</p> 	<p> Press and hold the key until the icon lights. ↓ E</p>
<p>2</p>	<p>Setting the number of stitches for inching sewing</p>  <p style="text-align: center;">↓  </p>  <p style="text-align: center;">E</p> <p style="text-align: center;">0 12</p> 	<p> Press the key to display the number of stitches E.</p> <p>Press the keys of the 1st to 3rd columns to set the number of stitches E.</p> <p> </p>
<p>3</p>	<p>Setting the pitch of the inching stitch</p>  <p style="text-align: center;">↑</p> 	<p>The pitch of the inching stitch is set with the key. </p>
<p>4</p>	<p>Setting the speed of inching sewing</p> <p>Use P09 of the memory switch to set the inching sewing speed.</p>	
<p>5</p>	 <p>If you continue to step on the treadle, sewing of the set number of stitches E is performed and the machine stops.</p>	

3. Operation panel

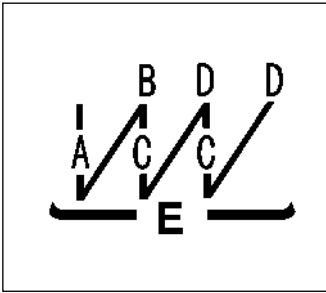
3-3-3. Continuous fixed stitching



<p>1</p>	<p>Setting of continuous stop stitching</p>	<p>Press the key so that the icon lights. </p>
<p>2</p>	<p>Setting the number of stitches for continuous stop stitching</p>	<p>Press the key in the first to fourth columns to set the corresponding number of stitches (A, B, C, D). </p>
<p>3</p>	<p>Set the number of repetitions of continuous stop stitching</p>	<p> Press the key to display the number of repetitions E.</p> <p>Press the key in the first and second row to set the number of repetitions E. </p> <p> Press the key to confirm the number of repetitions E.</p>

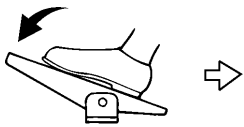

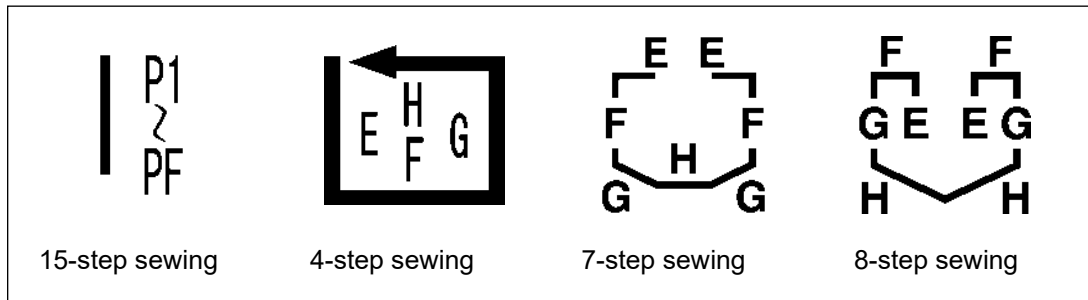

<p>4</p>	<p>Sewing pitch setting for continuous stop stitching</p> 	<p>The pitch of the continuous stop stitch is set with the key. </p>
<p>5</p>	<p>Setting the speed of continuous stop stitching</p>	<p>The speed of continuous stop stitching is set with P06 on the memory switch.</p>
<p>6</p>		<p>Just by stepping on the treadle, after sewing one cycle of the set number of stitches, thread trimming is performed automatically and stops on the needle.</p> <p>e.g., ABC when E is 3 ABCDCD when E is 6</p>

3. Operation panel



3-3-4. Step sewing



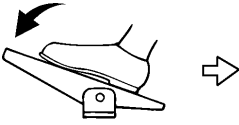



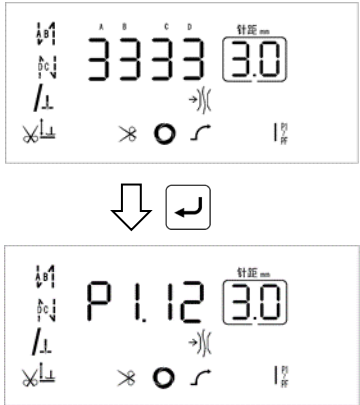

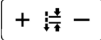



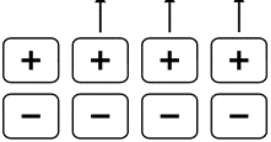

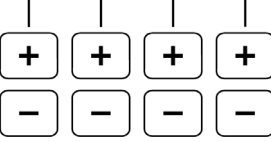
3-3-4-1. Step sewing setting

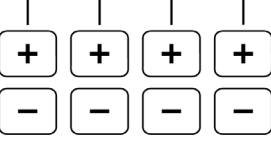
<p>1</p>	<p>Selection of step sewing for common pitch</p>  <p>↓  Press and hold</p> 	<p>Press and hold the key in the home screen to switch the sewing pattern to step sewing with a common pitch. </p> <p>Press and hold to switch the number of steps.</p> <p>15-step sewing → 4-step sewing → 7-step sewing → 8-step sewing → 15-step sewing → ..</p>
<p>2</p>	<p>Setting the speed of step sewing</p> <p>The speed of the step sewing is set with P09 of the memory switch.</p> <p>The number of stitches and pitch are set in "Step edit mode of common pitch".</p>	
<p>3</p>	 <p>Step stitching is performed at a common pitch when the treadle is stepped on.</p>	

3-3-4-2. Step edit mode

<p>1</p>	<p>Shift to Step Sewing Editing of Common Pitch</p> 	<p>Pressing the key with the step sewing of common pitch selected switches to the step editing mode of common pitch. </p>
<p>2</p>	<p>Pitch setting</p> 	<p> Use the key to set the pitch (0.0 to 5.0). The pitch is common to all steps.</p>

3. Operation panel

<p>3</p>	<p>Setting the number of stitches</p> <p><For 15 steps></p>  <p>↑ ↑ ↑ ↑</p>  <p><For 4/7/8 steps></p>  <p>↑ ↑ ↑ ↑</p>  <p>↓ ↩</p>  <p>↑ ↑ ↑ ↑</p> 	<p><For 15 steps></p> <ul style="list-style-type: none"> Use the keys in columns 3 and 4 to set the number of stitches (00 to 99).  *When 0 hand is set, that step and subsequent steps are disabled. Use the keys in the second column to select the step number (P1-PF).  <p><For 4/7/8 steps></p> <ul style="list-style-type: none"> Set the number of stitches E (00 to 99) with the keys of the 1st and 2nd columns.  Use the keys in columns 3 and 4 to set the number of stitches F (00 to 99).  Press the key to display the number of stitches G and the number of stitches H.  Set the number of stitches G (00 to 99) with the keys of the 1st and 2nd columns.  Set the number of stitches H (00 to 99) with the keys of the third and fourth columns.  *When 0 hand is set, only that step is invalid.
<p>4</p>	<p>End of common step sewing editing</p>	<p>When you have finished making sets, press the key to return to the home screen. </p>

3-3-5. Step stitching with arbitrary pitch

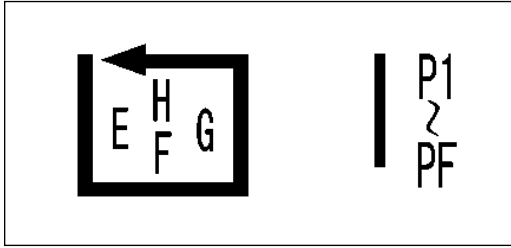









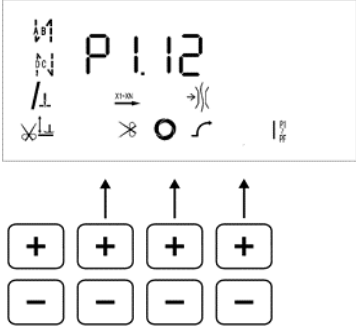
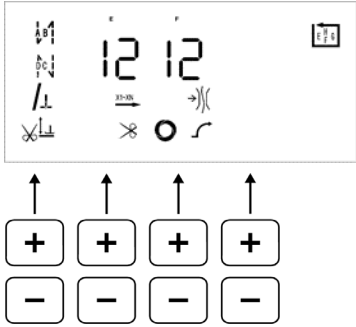
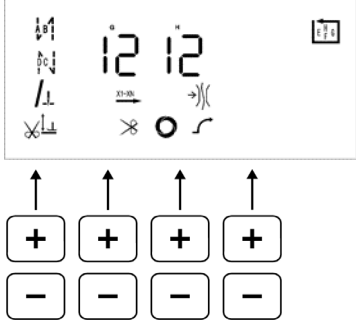

3-3-5-1. Step sewing setting of arbitrary pitch







<p>1</p>	<p>Selection of step sewing with arbitrary pitch</p>	<p>Press the key in the home screen to switch the sewing pattern to step sewing with a desired pitch. </p> <p>*Default value is 15-step sewing.</p> <p>In this state, you can switch to 4-step sewing by pressing the key. </p>
<p>2</p>	<p>Setting the speed of step sewing</p>	<p>The speed of the step sewing is set with P09 of the memory switch.</p> <p>The number of stitches and pitch can be set in the "Step edit mode with arbitrary pitch".</p>
<p>3</p>		<p>Step sewing is performed at the pitch set for each step when the treadle is stepped on.</p>

3. Operation panel

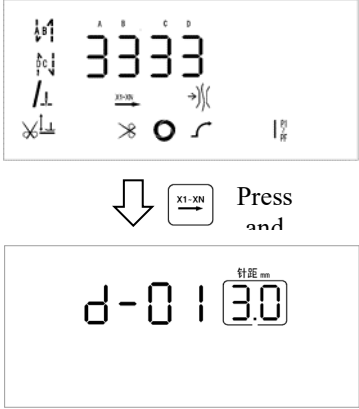

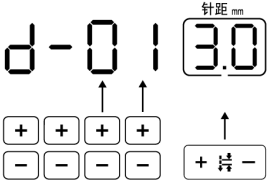
3-3-5.2. Step edit mode with arbitrary pitch (number of stitches)

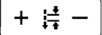
<p>1</p>	<p>Move to step editing mode (number of stitches) of arbitrary pitch</p>  	<p>When the key is pressed with the step sewing of the desired pitch selected, the mode switches to the step editing mode (number of stitches) of the desired pitch. </p>
<p>2</p>	<p>Setting the number of stitches <For 15 steps></p>  <p><For 4 steps></p>  	<p><For 15 steps></p> <ul style="list-style-type: none"> Use the keys in columns 3 and 4 to set the number of stitches (00 to 99).  *When 0 hand is set, that step and subsequent steps are disabled. Use the keys in the second column to select the step number (P1-PF).  <p><For 4 steps></p> <ul style="list-style-type: none"> Set the number of stitches E (00 to 99) with the keys of the 1st and 2nd columns.  Use the keys in columns 3 and 4 to set the number of stitches F (00 to 99).  Press the key to display the number of stitches G and the number of stitches H.  Set the number of stitches G (00 to 99) with the keys of the 1st and 2nd columns.  Set the number of stitches H (00 to 99) with the keys of the third and fourth columns.  *When 0 hand is set, only that step is invalid.
<p>3</p>	<p>End of step editing mode (number of stitches) of arbitrary pitch</p>	<p>When the setting is completed, press the key to return to the home screen. </p>

3-3-5-3. Step edit mode with arbitrary pitch

<p>1</p>	<p>Move to step editing mode (pitch) of arbitrary pitch</p> 	<p>Pressing and holding the key while a step sewing with an arbitrary pitch or a step sewing with a common pitch is selected switches to the step editing mode (pitch) with an arbitrary pitch. </p>
<p>2</p>	<p>Pitch setting</p> 	<ul style="list-style-type: none"> · Use the keys in the third and fourth columns to select the step number (01-15).   · Use the key to set the pitch (0.0 to 5.0) corresponding to the step number. 
<p>3</p>	<p>End of step editing mode (pitch) of arbitrary pitch</p>	<p>When the setting is completed, press the key to return to the home screen. </p>

3-4. How to set the sewing speed

In the Home screen, you can change the current sewing speed by pressing the/ key. If it is changed during sewing, it will be reflected from the next sewing.  







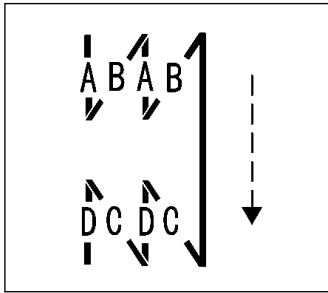

* The target speed is the speed currently selected.

Normal sewing speed (P01)/Continuous stop sewing speed (P06)/Inching sewing speed (P09)/Design stitch sewing speed (P69)

*When you change the value, the value of the corresponding memory switch (P01/P06/P09/P69) is also automatically changed.







3-5. How to set the front start and bcktack stitches



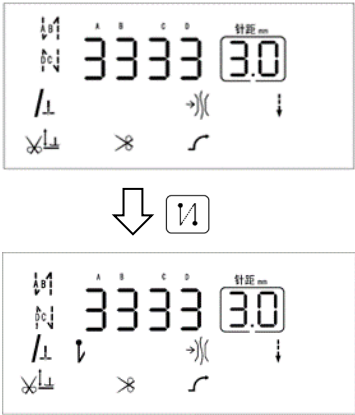









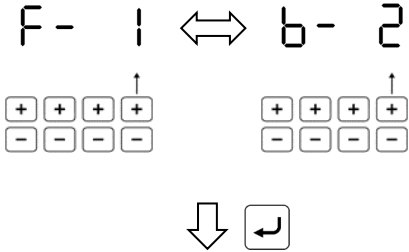

1	<p>Selection of type of pre-stop stitching</p>	<p> Press the key to select the type of pre-stop sewing.</p> <p> → → → → without → </p>
2	<p>Setting the number of stitches for pre-stop stitching</p> <p style="text-align: center;">A B</p> <p style="font-size: 2em; text-align: center;">3 3</p> <p style="text-align: center;">↑ ↑</p> <p style="text-align: center;">+ + - -</p>	<p>Press the first and second row keys to set the corresponding number of stitches (A and B). <input type="button" value="+"/> <input type="button" value="-"/></p> <p>*The speed of the pre-stop stitching is set with P04 on the memory switch.</p>
3	<p>Pitch setting.</p> <p style="text-align: center;">针距 mm</p> <p style="font-size: 2em; text-align: center;">3.0</p> <p style="text-align: center;">↑</p> <p style="text-align: center;">+  -</p>	<p>The pitch of the pre-stop stitch is set with the key. <input a="" and="" data-bbox="1145 1025 1193 1070" icon="" key="" slash="" square"="" type="button" value="+ -"/></p>
4	<p>Type setting of post-stop sewing</p>	<p> Press the key to select the type of post-stop sewing.</p> <p> → → → → without → </p>
5	<p>Setting the number of stitches for stitching after stopping</p> <p style="text-align: center;">C D</p> <p style="font-size: 2em; text-align: center;">3 3</p> <p style="text-align: center;">↑ ↑</p> <p style="text-align: center;">+ + - -</p>	<p>Press the keys in the third and fourth columns to set the corresponding number of stitches (C and D). <input type="button" value="+"/> <input type="button" value="-"/></p> <p>*The sewing speed for the post-stop sewing is set with P05 on the memory switch.</p>
6	<p>Pitch setting of post-stop stitching</p> <p style="text-align: center;">针距 mm</p> <p style="font-size: 2em; text-align: center;">3.0</p> <p style="text-align: center;">↑</p> <p style="text-align: center;">+  -</p>	<p>The pitch of the post-stop sewing is set with the key. <input a="" and="" data-bbox="1145 1776 1193 1821" icon="" key="" slash="" square"="" type="button" value="+ -"/></p>

3-6. How to set up condensation sewing

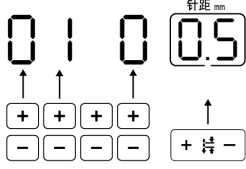
3-6-1. Additional setting of condensation sewing

<p>1</p>	<p>Addition of condensation stitching</p> 	<p>Press the key on the home screen to add condensation sewing. </p> <p>Each press toggles the icon as shown below.</p> <p>No → → → →.. </p> <p> If sewing is performed with the indication, a condensation stitch is added at the start of sewing.</p> <p> If sewing is performed with the indication, a condensation stitch is added at the end of sewing.</p> <p> If sewing is performed with the indication displayed, condensation sewing is added to the sewing start and end.</p>
<p>2</p>	<p>Setting of Condensation Sewing Conditions</p>	<ul style="list-style-type: none"> · Conditions for condensation sewing are set in "Condensation editing mode". · The sewing speed of the condensation at the start of sewing is set with P107 of the memory switch. · The sewing speed of the condensation at the end of sewing is set with P154 of the memory switch.

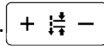
3-6-2. Condense edit mode

1	<p>Entering Condense Edit Mode</p>  <p>Press and</p> 	<p>Press and hold the key on the Home screen to switch to the Condense Edit mode. </p>
2	<p>Selecting the Edit Point (Sewing Start/Sewing End)</p>  	<p>Press the key in the fourth row to select "" (sewing start side) or "" (sewing end side).   F- 1b- 2</p> <p> Press the key to display the number of stitches, sewing direction and pitch.</p>
3	<p>To change a set value</p> 	<ul style="list-style-type: none"> Set the number of stitches (00 to 12) with the keys of the 1st and 2nd columns.   Use the key in the fourth row to set the sewing direction (0: forward, 1: reverse).   Use the key to set the pitch (0.0 to 5.0). 
4	<p>Setting Confirmation</p>	<p>When you have finished making sets, press the key to confirm. Returns to "" or ""  F- 1b- 2</p>
5	<p>Exiting Condense Edit Mode</p>	<p>When the setting is completed, press the key to return to the home screen. </p>

3. Operation panel

3-7. How to set the main part design stitch

3-7-1. Design stitching of main section



When sewing is performed by making the main part into a design stitch, sewing of effective groups is repeated as shown below.

<Example>





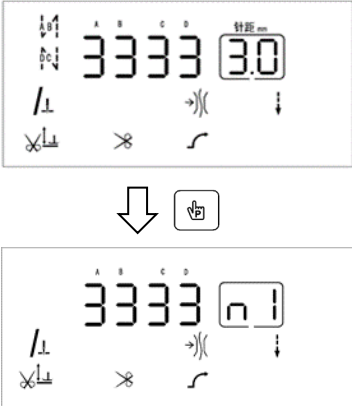

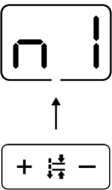
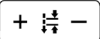

Group 1 → Group 2 → Group 3 → Group 1 →...

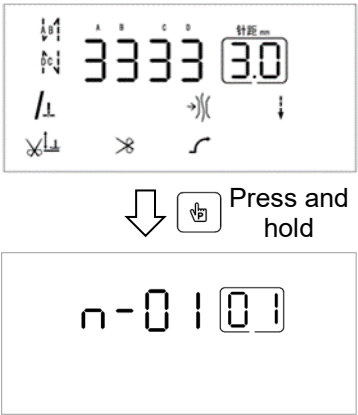
0.5mm×5 stitches 2.0mm×3 stitches 4.0mm×2 stitches 0.5mm×5 stitches

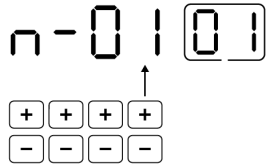
To cancel the design stitching of the main part, press the key. 

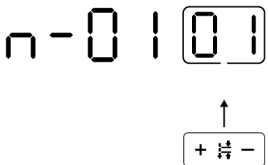
1	<p>Design stitching of main section</p> 	<p>Press the key in the home screen to design stitch the pitch of the main part. </p> <p>Press the key again to cancel the design stitching. </p>
2	<p>Selecting a Design Stitch Number</p> 	<p> With the key, select the design stitch number (n1 to n9).</p> <ul style="list-style-type: none">· Design stitch registration is set in "Design stitch editing mode of main part".· The design stitch sewing speed of the main part is set with P69 of the memory switch.

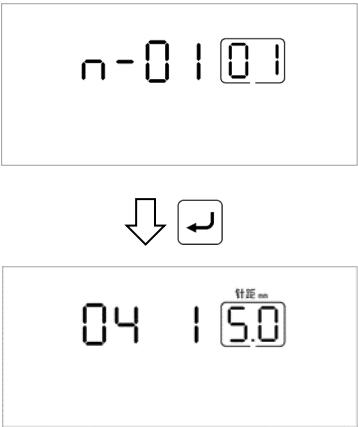
3-7-2. Design stitch of the main part Edit mode

1	<p>Moving to Design Stitch Editing in the Main Section</p> 	<p>Press and hold the key in the home screen to switch to the design stitch editing mode in the main part. </p>
2	<p>Selecting a Design Stitch Number</p> 	<p>In the fourth row, select the design stitch number (n-01~n-09).  </p>
3	<p>Selecting a group number</p> 	<p> Press the key to select the group number (01 to 10).</p>
4	<p>Move to group editing</p> 	<p>Next, press the key to switch to the group edit mode. </p>

3. Operation panel

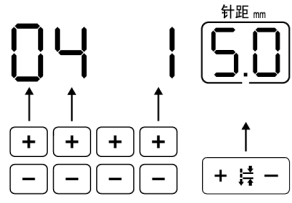
5	<p>To change a set value</p>  <p>The diagram shows a digital display with '04' and '5.0'. Above '04' are four '+' buttons and below are four '-' buttons. Above '5.0' is a '+' button and below is a button with a needle icon and a '-' button. An arrow points from the needle icon button to the '5.0' display. The text '针距 mm' is above the '5.0' display.</p>	<ul style="list-style-type: none"> · Set the number of stitches (00 to 99) with the keys of the 1st and 2nd columns. + - *When the 0 hand is set, that group and subsequent groups are disabled. · Use the keys in the fourth column to set the number of iterations (1, 3, 5, 7, 9). + - · Use the key to set the pitch (0.0 to 5.0). + 针距 - *When 0.0mm is set, only that group is disabled.
6	Ending Group Editing	<p>When the setting is completed, press the key to return to the design stitch editing mode in the main section. ↩</p>
7	Finishing Design Stitch Editing in the Main Section	<p>P Press the key to return to the home screen.</p>

3-8. How to set the stitch for the sewing stop design

3-8-1. Design stitching of sewing stops







When sewing is performed by making the stop sewing part into a design stitch, sewing of effective groups is repeated as shown below.

<Example>

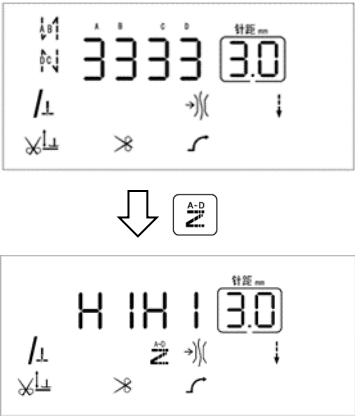
When the number of inching stitches E is set to 10 stitches, the number of design stitch No. 1 (H1) is set to 1.0mm×4 stitches, and the number of design stitch No. 2 (H2) is set to 0.5mm×8 stitches, and H1H2 4 is set to 0,

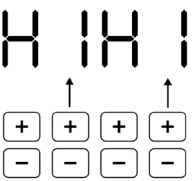

















Pre-stop sewing (H1) → inching sewing → Post-stop sewing (H2)





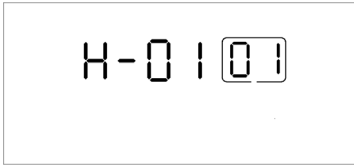

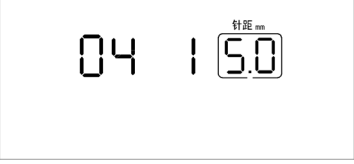
1.0mm×4 needles 4.0mm×10 needles 0.5mm×8 needles

1	<p>Design stitching of sewing stops</p> 	<p>Press the key in the home screen to design stitch the pitch of the sewing stop. </p> <p>*However, it is invalid when the main part is a design stitch sewing and when it is a continuous stop sewing.</p> <p>Press the key again to cancel the design stitching. </p>
2	<p>Selecting a Design Stitch Number</p> 	<ul style="list-style-type: none"> · In the second row of keys, select the design stitch number (1 to 9) for the pre-stop stitch.   · In the fourth row of keys, select the design stitch number (1 to 9) for the post-stop stitch.   · Design stitch registration is set in "Design stitch editing mode for sewing stop". · The sewing speed at the front stop follows P04, and the sewing speed at the rear stop follows P05.

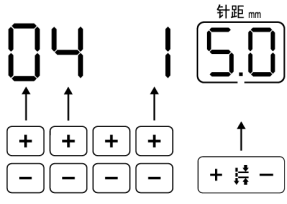
3. Operation panel

3-8-2. Design stitch editing mode for sewing stops

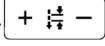
<p>1</p>	<p>Shift to Design Stitch Editing of Stitch Sewing Section</p>  <p>↓  Press and hold</p> 	<p>Press and hold the key in the Home screen to switch to Design Stitch Edit mode for the sewing stop. </p>	
<p>2</p>	<p>Selecting a Design Stitch Number</p>  <p> </p>	<p>In the fourth row, select the design stitch number (H-01~H-09).   <p>↑   </p> </p>	<p>   Press the key to select the group number (01 to 10).</p>
<p>4</p>	<p>Move to group editing</p>  <p>↓ </p> 	<p>Next, press the key to switch to the group edit mode. </p>	

<p>5</p>	<p>To change a set value</p> 	<ul style="list-style-type: none"> · Set the number of stitches (00 to 99) with the keys of the 1st and 2nd columns.   *When the 0 hand is set, that group and subsequent groups are disabled. · Use the keys in the fourth column to set the number of iterations (1, 3, 5, 7, 9).   · Use the key to set the pitch (0.0 to 5.0).  *When 0.0mm is set, only that group is disabled.
<p>6</p>	<p>Ending Group Editing</p>	<p>After the setting is completed, press the key to return to the design stitch editing mode of the sewing stop. </p>
<p>7</p>	<p>End of Design Stitch Editing of Stitch Sewing Section</p>	<p> Press the key to return to the home screen.</p>

3-9. Checking method of the production counter

The current production counter can be checked on P41.

*When P17-N12 is set to "1", the production counter can be displayed when the power is turned on.

The counting units can be changed with P17-N06.

The counting direction can be changed with P17-N13.

3-10. How to set up the handy switch

Use P174 to set the function of handy switch A (upper row).

Use P15 to set the function of handy switch B (lower row).

3-11. How to confirm the software version

Main Control Version: This can be checked in P42-N01.

Panel Control Version: This can be checked in P42-N02.

Reverse motor control version: Can be checked on P42-N15.

3-12. How to set head specifications

In P70 the following

-3: -3 Specification

-5: -5 Specification

-7: 7 mm Specification

[Precaution]

If you change the value of P70 and press the key, the settings other than P92 will return to the factory default settings. 

3-13. Data initialization method

There are three ways to initialize data:

A: On the Home screen, press and hold the key to initialize the data other than the following to the factory default settings.

Reset

P17-N04, P18, P19, P25, P26, P32, P33, P58, P59, P70, P74, P75, P92, P129, P144, P145,
P177~P200, P23~P242

Normally, memory switches other than those listed above are initialized to the factory default settings. However, memory switches with default settings that are different from the factory default settings are restored to their default settings.

*After confirming the value of the memory switch with the key, press and hold the key to set the default value that is different from the factory setting. 

B: In mechanic memory switch mode, select P124, enter the panel version, and press to initialize the data other than the following to the factory default settings. 

P17-N04, P18, P19, P25, P26, P32, P33, P58, P59, P70, P74, P75, P92, P129, P144, P145,
P177~P200, P235~P242

C: In the mechanic memory switch mode, select P70 and press the key to initialize data other than P92 to the factory default settings. 

*Initialization is performed only when the value of P70 is changed. Therefore, after changing to a value other than the desired value, it is necessary to return to the desired value.

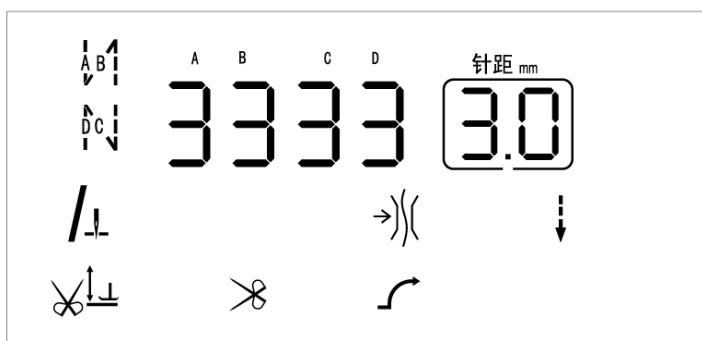

3-14. Memory Switch

Parts Number	Item	Range	Initial value	Description
P01	Maximum Speed of Normal Sewing (sti/min)	100-[P68]	-3 Specification 4000	Maximum speed for normal sewing *The upper limit of the setting range is the value of P68.
			-5 Specification 4000	
			7 mm Specification 3000	
P02	Adjust acceleration curve (%)	10-100	80	Climbing slope setting of the speed controller The higher the slope value, the steeper the speed. The lower the slope value, the slower the speed.
P03	Invalid			
P04	Pre-stop sewing speed (sti/min)	200-3200	1800	Speed when sewing pre-stop sewing (A, B)
P05	Post-stop sewing speed (sti/min)	200-3200	1800	Speed when sewing post-stop sewing (C, D)
P06	Sequential sewing speed (sti/min)	200-3200	1800	Speed when sewing continuous stop stitches (A, B, C, D)
P07	Slow start speed (sti/min)	200-1500	700	Slow start speed
P08	Number of slow start hands (stitches)	1-15	2	Number of slow start stitches
P09	Inching sewing speed (sti/min)	200-4000	3700	Speed when sewing inching sewing
P10	Automatic stop sewing function after inching sewing	ON/OFF	ON	ON: Stop sewing is automatically executed after inching sewing. OFF: Stop sewing is not executed automatically after inching sewing. The pedal must be depressed to perform a post-stop sewing.
P11	Overall Solenoid Timing Correction when Stitching	-20-20	0	This setting value is added to P18, P19, P25, P26, P32, and P33 when the stop stitching operation is performed.
P12	Pedal operation mode.	0-1	1	0: Pedal operation is possible, and any stop and start are possible. 1: A series of sewing operations is performed automatically when the pedal is lightly touched
P13	Operation mode at the end of pre-stop sewing	CON/STP	CON	CON: Next sewing is performed without stopping after completion of the pre-stop sewing. STP: Stops after completion of pre-stop sewing.
P14	Invalid			

Parts Number	Item	Range	Initial value	Description
P15	Operation of handy switch B (lower row)	0-6	5	0: No function 1: Half stitch stitch 2: Single stitch sewing 3: Continuous semi-needle stitch 4: Continuous single stitch sewing 5: Reverse stitch 6: Condensation seam
P16	Reverse sewing speed (sti/min) with handy switch	0-3200	3000	When the value is 0, it is disabled (remains at the current speed).
P17 N01 ~ P17 N03	Invalid			
P17 N04	Audio Settings	0-6	0	0: OFF 1: Chinese 2: English 3: Vietnamese 4: Portuguese 5: Turkish 6: Spanish
P17 N05	Choosing a Voice Announcement	0-3	1	0: OFF 1: No Key Sound 2: Have a keypad sound 3: OFF
P17 N06	Count unit of the production counter (thread trimming count)	0-50	1	0: Do not count 1-50: Production count is counted one by the set number of thread trimming operations.
P17 N07	Invalid			
P17 N08	Presence/absence of setting ratio between setting speed and actual speed	0-1	0	0: Invalid 1: Real speed ratio of sewing speed over 4000 is set. (The setting of N09 below becomes effective.)
P17 N09	Ratio of set speed to actual speed (%)	10-100	50	When the set velocity is 4000 sti/min or more, Actual speed is set to 4000+100*.
P17 N10	Invalid			
P17 N11	Invalid			

3. Operation panel

Parts Number	Item	Range	Initial value	Description
P17 N12	Production counter display at power-on	0-1	0	0: Not display 1: Displaying the production counter when the power is turned on (P41 is selected.)
P17 N13	Count direction of the production counter	0-1	0	0: Up direction, 1: Down direction
P17 N14	Invalid			
P17 N15	Invalid			
P17 N16	Screen Contrast	0-10	4	Increasing the value increases the difference between light and dark on the screen.
P18	Solenoid ON timing for pre-stop sewing	0-200	165	Decreasing the value will shorten the length of A in the pre-stop sewing. And the length of B of the pre-stop stitch is increased. Increasing the value increases the length of A in the pre-stop stitch. Also, the length of B of the pre-stop stitch is shortened.
P19	Solenoid OFF timing for pre-stop stitching	0-200	165	Decreasing the value will shorten the length of B for the pre-stop sewing. Increasing the value increases the length of B in the pre-stop stitch.
P20	Invalid			
P21	Pedal acceleration position	30-1000	520	Pedal acceleration position
P22	Pedal return position	30-1000	420	Pedal return position
P23	Pedal depression position	30-1000	270	Pedal depression position
P24	Pedal thread trimming position	30-500	130	Pedal thread trimming position
P25	Solenoid ON timing of post-stop sewing	0-200	165	Decreasing the value will shorten the length of D for the post-stop sewing. Also, the length of C of the stop stitch will be longer. Increasing the value increases the length of D for the post-stop sewing. Also, the length of C of the stop stitch will be shortened.



Parts Number	Item	Range	Initial value	Description
P26	Solenoid OFF timing of post-stop sewing	0-200	165	Decreasing the value will shorten the C length of the post-stop sewing. Also, the length of D of the stop stitch becomes longer. Increasing the value increases the length of C for the post-stop sewing. Also, the length of D of the stop stitch is shortened.
P27	Invalid			
P28	Invalid			
P29	Braking force when the sewing machine motor stops	1-45	20	Increasing the value increases the brake force.
P30	Invalid			
P31	Invalid			
P32	Solenoid ON timing for continuous stop stitching	0-200	165	Stitch compensation for continuous back stitch A(C) part, stepwise delay of 0 to 200 action. The larger the number, the longer the last needle in the A(C) segment. B(D) As the first needle in the segment is shorter
P33	Solenoid OFF timing for continuous stop stitching	0-200	165	Stitch compensation of continuous back stitch B(D) part, stepwise delay of 0 to 200 action. The larger the number, the longer the last needle in the B(D) segment and the shorter the first needle in the C segment.
P34	Invalid			
P35	Yarn loosening operation during presser foot lifting operation	0-2	1	0: Close 1: Turns on the loose line output function when raising the foot, and turns off the loose line output function when stopping halfway. 2: Looseness line output function when the foot is raised and looseness line output function when the foot is stopped halfway are turned on.
P36	Invalid			
P37	Strength of thread presser foot at sewing start	0-11	6	0: Thread wiping operation 1: Thread wiping operation 2~11: The larger the value, the stronger the operation force of the thread retainer.
P38 ~ P40	Invalid			

3. Operation panel

Parts Number	Item	Range	Initial value	Description
P41	Production counter	0-9999	0	You can view and edit production counters. When the up-counting method (P17-N13 = 0) is selected, it can be decreased by keying <input type="button" value="-"/> * Press and hold the key to clear the counter. <input type="button" value="-"/> When the down-counting method (P17-N13 = 1) is selected, it can be increased by keying <input type="button" value="+"/> .
P42 N01	Main control version		9	Main control version
P42 N02	Panel control version		2108	Panel control version
P42 N03	Speed signal		0	
P42 N04	Foot pedal AD value		Around 328	
P42 N05	Upper Axis Angle (Needle Upper Reference)		With UP Around 0	
P42 N06	Vertical Axis Angle (Needle Lower Reference)		With UP Around 180	
P42 N07	Voltage AD value		Around 286	
P42 N08 ~ P42 N10	Invalid			
P42 N11	Detailed information when an error occurs		0	0: Normal Other information: Contact CKD for details.
P42 N12 ~ P42 N14	Invalid			
P42 N15	Reverse motor control version		-	Reverse motor control version (currently 183)
P42 N16	Bobbin thread counter (10 needle units)		0	Displays the current bobbin thread counter. *Counting rules and defaults follow P165, P166.

Parts Number	Item	Range	Initial value	Description
P42 N17	Accumulated number of hands (in units of 0.1 million stitches)		0	Displays the current accumulated number of hands.
P42 N18 ~ P42 N25	Invalid			
P43	Invalid			
P44	—	1-45	16	Do not change.
P45	Selecting Free Stitch Motion Mode for Patterns	0-1	0	0: Pedal operation is possible, and any stop and start are possible. 1: A series of sewing operations is performed automatically when the pedal is lightly touched
P46	Reverse needle lifting function after thread trimming	ON/OFF	OFF	ON: Reverse needle lifting operation after thread trimming OFF: No reverse needle lifting operation after thread trimming
P47	Reverse needle lift angle after thread trimming	10-300	40	Adjust the angle to lift the needle in reverse rotation by counting from the top needle position after cutting the thread.
P48	Min. sewing speed (sti/min)	100-500	210	Min. sewing speed when sewing with pedal operation
P49	Sewing Speed for Thread Cutting (sti/min)	100-500	300	During thread cutting backtack.
P50	-	10-990	150	Do not change.
P51	-	1-50	30	Do not change.
P52	-	10-990	120	Do not change.
P53	Pressing operation when pedal is depressed	0-2	1	0: The presser foot does not move up. 1: Presser foot lifts when half-stepped back 2: Presser foot lift operation with full depression
P54	Thread trimming operation time (ms)	10-990	200	Thread trimming operation time (ms)
P55	Yarn dispensing operation time (ms)	10-990	10	Yarn dispensing operation time (ms) *Valid when P111 is "1"
P56	Invalid			
P57	Protection time of presser foot solenoid (s)	1-60	5	Forcibly turn off after holding time to prevent burns caused by long solenoid suction
P58	Needle up stop position	0-359	283	The value stored in P72 is displayed. *You cannot change the value here.
P59	Needle down stop position	0-359	88	The value stored in P73 is displayed. *You cannot change the value here.



3. Operation panel

Parts Number	Item	Range	Initial value	Description
P60	-	100-4000	3500	Do not change.
P61	-	ON/OFF	OFF	Do not change.
P62	-	ON/OFF	OFF	Do not change.
P63	-	ON/OFF	OFF	Do not change.
P64	-	1-250	30	Do not change.
P65	-	1-250	10	Do not change.
P66	Invalid			
P67	Invalid			
P68	Sewing speed upper limit (sti/min)	-3 Specification 100-5000	-3 Specification 4000	Sewing speed upper limit for the whole sewing machine. This value limits the setting range of P01 and P60.
		-5 Specification 100-4000	-5 Specification 4000	
		7 mm Specification 100-4000	7 mm Specification 3500	
P69	Design stitching speed (sti/min)	100-3000	2000	Design stitch backtack.
P70	Selecting and Initializing Head Specifications	-3/-5/-7	-3	Select the head specification and perform initialization corresponding to that specification.
P71	Corrective sewing pitch with hand switch B (mm)	0-5.0	0	If it is set to 0, the correction sewing is performed at the current pitch.
P72	Needle up stop position adjustment	0-359	Around 283	Adjust the needle upward stop position while turning the pulley by hand, and then press the key to save the current position (numerical value) as the needle upward stop position.  [Precaution] The displayed value is the current reading. Use P58 to check the set value.
P73	Needle down stop position adjustment	0-359	88 back and forth	By adjusting the needle lower stop position while turning the pulley by hand and pressing the key, the current position (numerical value) can be saved as the needle lower stop position.  [Precaution] The displayed value is the current reading. Use P59 to check the set value.

Parts Number	Item	Range	Initial value	Description
P74	Positive-pitch compensation at low speeds (< 1000 sti/min)	-100~100	0	Increasing the value increases the pitch.
P75	Reverse-pitch compensation at low speeds (< 1000 sti/min)	-100~100	0	Increasing the value increases the pitch.
P76	Invalid			
P77	Timing of turning on the solenoid when sewing backward	0-350	120	Decreasing the value will shorten the C length of the post-stop sewing. Increasing the value increases the length of C for the post-stop sewing.
P78	Thread presser foot ON angle	5-359	100	Thread presser foot ON angle
P79	Thread presser foot OFF angle	5-359	270	Thread presser foot OFF angle
P80 ~ P87	Invalid			
P88	-	10-100	30	Do not change.
P89	Voltage rise error detection voltage	410-420	410	Set the voltage to detect the voltage rise error (E01). (It will be about 1.4 times the power supply voltage)
P90	Slow start first needle speed	200-1500	400	Slow start first needle speed
P91	Second needle speed at the start of low-speed sewing	200-1500	1000	Second needle speed at the start of low-speed sewing
P92	Sewing machine motor electric angle correction		Around 600	 By pressing the key, the upper shaft rotates slowly one turn Read the start angle of the encoder. It is set at the factory. Do not change the value of the parameter by itself (it is not possible to change the value of the parameter manually. If it is changed by itself, an abnormality or damage may occur to the control box and motor).
P93	Half-depressed operating time (ms)	10-900	100	Half-depressed operating time (ms)
P94	Invalid			
P95	-	10-100	80	Do not change.
P96	-	0-20	10	Do not change.
P97	-	0-10	5	Do not change.
P98 ~ P100	Invalid			

3. Operation panel

Parts Number	Item	Range	Initial value	Description
P101	Thread release start angle	1-359	30	Thread loosening start angle (The lower position is calculated as 0°)
P102	Thread release end angle	1-359	180	Thread loosening end angle (the position below is calculated at 0° and must be greater than the value of P101 parameter)
P103	Yarn release strength	1-8	5	Yarn release strength
P104 ~ P106	Invalid			
P107	Sewing speed at sewing start	100-2000	500	Sewing speed at sewing start
P108	Invalid			
P109	Pre-dial delay time?	5-990	5	Time from finding the upper position to entering the dial operation
P110	Trimming back time (ms)	60-990	65	Check that the thread trimmer has returned to the original position.
P111	-	0-1	0	Do not change.
P112	-	0-990	100	Do not change.
P113	-	0-990	90	Do not change.
P114	-	0-990	30	Do not change.
P115	-	0-100	80	Do not change.
P116	-	0-5000	1000	Do not change.
P117	-	0-100	80	Do not change.
P118	-	0-1	1	Do not change.
P119	Overcurrent protection detection of solenoid	0-1	0	0: OFF 1: You do.
P120 ~ P122	Invalid			
P123	Maximum stitch limit	0-7	5	The upper limit of P131, P132, etc., is limited.
P124	Restoring the Factory Default Settings	0000-9999	0000	Enter the version number of the panel and press the key to initialize all data based on the setting of P70.  Provided, however, that the following shall be excluded. P17-N04、 P18、 P19、 P25、 P26、 P32、 P33、 P58、 P59、 P70、 P74、 P75、 P92、 P129、 P144、 P145、 P177~P200、 P235~P242
P125 ~ P128	Invalid			
P129	Home position correction of the reversing motor	-500~500	0	Home position correction of the reversing motor
P130	Invalid			
P131	Invalid			

Parts Number	Item	Range	Initial value	Description
P132	Condense pitch setting with handy switch	0-5.0	2.0	Pitch of condensation stitching *It is enabled when the handy switch operation is set to condensation sewing.
P133 ~ P137	Invalid			
P138	Duty at presser foot lowering (%)	0-100	2	Decreasing the value will make the sound weaker and lower.
P139	Delay time for presser foot lowering (ms)	0-200	8	Increasing the value delays the downward movement. (P138 and setting)
P140 ~ P143	Invalid			
P144	Positive pitch compensation at high speed (1000 sti/min or higher)	-100~100	-020	Increasing the value increases the pitch.
P145	Reverse-pitch compensation at high speeds (1000 sti/min or higher)	-100~100	-020	Increasing the value increases the pitch.
P146 ~ P153	Invalid			
P154	Final sewing condensation sewing speed	100-2000	1000	Final sewing condensation sewing speed
P155 ~ P164	Invalid			
P165	Bobbin thread counter	0-4	0	<p>0: The bobbin thread counter is not counted.</p> <p>1: Increment the bobbin thread counter. When the upper limit (P166) is reached, the bobbin thread counter returns to 0.</p> <p>2: Decrement the bobbin thread counter. When it reaches 0, the bobbin thread counter returns to the upper limit (P166).</p> <p>3: The bobbin thread counter is incremented. When the upper limit (P166) is reached, "E51" is displayed and sewing is suspended. Press the key to clear the bobbin thread counter and cancel the error. </p> <p>4: Decrement the bobbin thread counter. When it reaches 0, "E51" is displayed and sewing stops.  Press to reset the upper limit (P166) to the bobbin thread counter.</p>

3. Operation panel

Parts Number	Item	Range	Initial value	Description
P166	Upper limit of bobbin thread counter (10-needle unit)	0-9999	500	It is the upper limit of counting up or the initial value of counting down.
P167	Upper limit value of accumulated needle count counter (in units of 0.1 million stitches)	0-9999	0	When the cumulative number of hands (P42-N17) reaches this value, "E28" is displayed.  Press and hold the key to clear the accumulated number counter and cancel the error. *If it is set to 0, it is invalid.
P168	Invalid			
P169	Invalid			
P170	Corrective sewing pitch (mm) with handy switch A	0-5.0	0	If it is set to 0, the correction sewing is performed at the current pitch.
P171 ~ P173	Invalid			
P174	Operation of handy switch A (upper row)	0-6	3	0: No function 1: Half stitch stitch 2: Single stitch sewing 3: Continuous semi-needle stitch 4: Continuous single stitch sewing 5: Reverse stitch 6: Condensation seam
P175	Invalid			
P176	Invalid			
P177	-	0-2000	55	Do not change.
P178	-	0-2000	55	Do not change.
P179	-	0-2000	110	Do not change.
P180	-	0-2000	108	Do not change.
P181	-	0-2000	155	Do not change.
P182	-	0-2000	153	Do not change.
P183	-	0-2000	200	Do not change.
P184	-	0-2000	195	Do not change.
P185	-	0-2000	240	Do not change.
P186	-	0-2000	234	Do not change.
P187	-	0-2000	278	Do not change.
P188	-	0-2000	272	Do not change.
P189	-	0-2000	318	Do not change.
P190	-	0-2000	310	Do not change.
P191	-	0-2000	0	Do not change.
P192	-	0-2000	0	Do not change.



Parts Number	Item	Range	Initial value	Description
P193	-	0-2000	0	Do not change.
P194	-	0-2000	0	Do not change.
P195	-	0-2000	0	Do not change.
P196	-	0-2000	0	Do not change.
P197	-	0-2000	0	Do not change.
P198	-	0-2000	0	Do not change.
P199	-	0-2000	0	Do not change.
P200	-	0-2000	0	Do not change.
P201	-	0-1	0	Do not change.
P202	-	0-359	1	Do not change.
P203	-	0-359	200	Do not change.
P204	-	0-100	60	Do not change.
P205	-	200-1500	0	Do not change.
P206	-	200-2000	0	Do not change.
P207	-	200-4000	0	Do not change.
P208 ~ P233	Invalid			
P234	-	0-1	0	Do not change.
P235	-	0-200	165	Do not change.
P236	-	0-200	160	Do not change.
P237	-	0-200	160	Do not change.
P238	-	0-200	160	Do not change.
P239	-	0-200	160	Do not change.
P240	-	0-200	160	Do not change.
P241	-	0-200	160	Do not change.
P242	-	0-200	160	Do not change.
P243	-	0-200	0	Do not change.
P244	-	-20~20	0	Do not change.
P245	-	0-8.0mm	5.5mm	Do not change.
P246	-	200-3000	1800	Do not change.
P247	-	-100~100	5	Do not change.
P248	-	-100~100	5	Do not change.
P249	-	50-1000	550	Do not change.
P250 ~ P253	Invalid			
P254	-	-100~100	0	Do not change.
P255	-	-100~100	0	Do not change.
P256	Invalid			

3-15. List of Error Code

Error code	Content	Recommended action
E01	Abnormal voltage rise	(1) Whether the grid-voltage is higher than AC260V (2) If power is supplied by private power generation, reduce the power of the generator. (3) If it still does not work properly, replace the control box and contact after-sales service.
E02	Abnormal voltage drop	(1) Whether to insert low voltage (2) Restores the factory default settings. (3) If it still does not work properly, replace the control box and contact after-sales service.
E03	Communication error between main CPU and panel CPU	(1) Turn off power to the system, check for loose or disconnected monitor cables, return to normal condition, and then restart the system. (2) If E05 or E03 occurs by turning off the system, removing the electronic control box, plugging in the power cord again and turning it on again, replace the control box and contact after-sales service.
E05	Abnormal speed control signal	(1) Check if the speed control connector is loose or disconnected, return to normal, and restart the system. (2) If it still does not work properly, replace the control box or speed control and contact after-sales service.
E07	Error sewing machine motor rotation	(1) Turn off the power and check if the handwheel rotates smoothly (handwheel) and check the machine if it cannot rotate. (2) Turn off the power, check if the power connector of the motor is loose, and then restart after connecting. (3) Check if the needle position above is correct. If it is incorrect, adjust the upper position. (4) If it still does not work, replace the control box or machine motor and contact after-sales service.

Error code	Content	Recommended action
E10	Overcurrent protection of solenoid	<p>(1) If alarm E10, etc. occurs, remove the solenoid interface, replace the control box, and notify after-sales service.</p> <p>(2) If the alarm does not sound when the solenoid connector is unplugged, replace the connector.</p> <p>1) The front pedal is made to reinforce the sewing by sandwiching a thread in the sewing machine, and if there is an alarm, the front and rear pedals are turned off, the electronic control is restarted by restarting, and if there is an alarm, the function to pinch the thread is turned off, and the electronic control is restarted, and if there is no alarm, the yarn pincher is replaced.</p> <p>2) The pre-tread pedal makes the sewing machine perform thread pinching and reinforcement sewing. If there is an alarm, turn off the pre-reinforcement and back-reinforcement, restart the electronic control, and if there is no alarm, turn off the yarn pinching function and restart the electronic control. Turn on the pre-reinforcement sewing function and perform the pre-step again. If there is an alarm, replace the reverse sewing solenoid.</p> <p>3) Pressing the pedal to have the sewing machine scissors and stiffen the thread. If there is no alarm, press the pedal halfway up to raise the foot. If there is an alarm, replace the foot solenoid.</p> <p>4) The sewing machine is preceded by pedaling to scissor and reinforce the thread, half-reversely stepping to hold down the foot, and if there is no alarm, all reversely stepping to cut the thread, and if there is an alarm, cut the thread and replace the solenoid.</p>
E09 E11	Positioning signal error of the sewing machine motor encoder	<p>(1) Turn off the system, check for loose or disconnected sewing machine motor encoder connectors, return to normal, and restart the system.</p> <p>(2) Check if the zero point correction setting of the motor is correct. Resetting the Motor Zero Correction.</p> <p>(3) Clean the encoder disc for oil, if any.</p> <p>(4) If it still does not work, replace the control box or machine motor and contact after-sales service.</p>
E14	Encoder signal error of sewing machine motor	<p>(1) Turn off the system, check for loose or disconnected sewing machine motor encoder connectors, return to normal, and restart the system.</p> <p>(2) Check if the grating is installed correctly (whether the grating screws are securely fastened and if the grating is positioned in the center of the encoder head).</p> <p>(3) Check if the raster code disc has oils. Clean and replace any oil before restarting the system.</p> <p>(4) If it still does not work, replace the control box or machine motor and contact after-sales service.</p>



3. Operation panel

Error code	Content	Recommended action
E15	Sewing machine motor drive overcurrent	<ol style="list-style-type: none"> (1) Check the motor power cord for loose connections. (2) Check that the power cord of the motor is not crushed. (3) Replace the control box or the sewing machine motor and inform us of the after-sales service.
E17	Falling of the sewing machine head was detected.	<ol style="list-style-type: none"> (1) Turn off the system and check that the sewing computer head is not tipping over. (2) Check whether the detection setting of the handpiece protection switch is correct. (3) If it still does not work, replace the control box or panel and contact after-sales service.
E20	The sewing machine motor failed to start.	<ol style="list-style-type: none"> (1) Turn off the system, check for loose or disconnected power cables and encoder connectors on the sewing machine motor, return to normal, and restart the system. (2) Check if the origin correction setting is correct. Re-setting the origin correction. (3) If it still does not work, replace the control box or machine motor and contact after-sales service.
E28	Maintenance warning	 Press and hold the key to cancel the error. *Refer to P167 of the memory switch.
E51	Warning without bobbin thread	 Press and hold the key to cancel the error. *Refer to P165 of the memory switch.
E80	Communication error between main CPU and stepping driver CPU	Replace the control box and inform us of the after-sales service.
E82	Overcurrent of the reversing motor	<ol style="list-style-type: none"> (1) Turn off the system and check if the reverse motor is caught. If it gets caught, first troubleshoot the mechanical failure of the head. If it is normal, check if the connector of the reversing motor is loose or disconnected, and restart the system after returning to the normal condition. (2) If it still does not work, replace the control box or reversing motor and contact after-sales service.
E84	Encoder positioning signal error of reverse motor	<ol style="list-style-type: none"> (1) Turn off the system and check if the reverse motor is caught. If it gets caught, first troubleshoot the mechanical failure of the head. If it is normal, check if the encoder connector of the reversing motor is loose or disconnected, and restart the system after returning to the normal condition. (2) Check if the grating is installed correctly (whether the grating screws are securely fastened and if the grating is positioned in the center of the encoder head). (3) Check if the raster code disc has oils. Clean and replace any oil before restarting the system. (4) If it still does not work, replace the control box or reversing motor and contact after-sales service.

Error code	Content	Recommended action
E85	Encoder signal error of reverse motor	<ol style="list-style-type: none"> (1) Turn off the power to the system, check if the encoder connector of the reversing motor is loose or disconnected, and restart the system after returning it to normal. (2) Check if the grating is installed correctly (whether the grating screws are securely fastened and if the grating is positioned in the center of the encoder head). (3) Check if the raster code disc has oils. Clean and replace any oil before restarting the system. (4) If it still does not work, replace the control box or reversing motor and contact after-sales service.
E86	The reverse motor failed to start.	<ol style="list-style-type: none"> (1) Turn off the power to the system, check if the power cable of the reverse motor and the connectors of the encoder are loose or disconnected, and restart the system after returning to normal. (2) Check if the grating is installed correctly (whether the grating screws are securely fastened and if the grating is positioned in the center of the encoder head). (3) Check if the raster code disc has oils. Clean and replace any oil before restarting the system. (4) If it still does not work, replace the control box or reversing motor and contact after-sales service.
E87	Abnormal rotation of reverse motor	<ol style="list-style-type: none"> (1) Turn off the system and check if the reverse motor is caught. If it gets caught, first troubleshoot the mechanical failure of the head. If it is normal, check that the power cable connector and encoder connector of the reverse motor are not loose or disconnected, and restart the system after returning to the normal condition. (2) If it still does not work, replace the control box or reversing motor and contact after-sales service.

3-16. About USB Ports

Note

-  Do not connect equipment that requires more than the following ratings to the USB port.
Voltage rating: DC5V
Maximum current rating :1 A
Connecting a device exceeding the rating may cause damage or malfunction of the sewing machine body or connected USB device.
-  When not using the USB port, be sure to cover the USB port with the connector cover. Failure to do so may cause dust to enter the product.



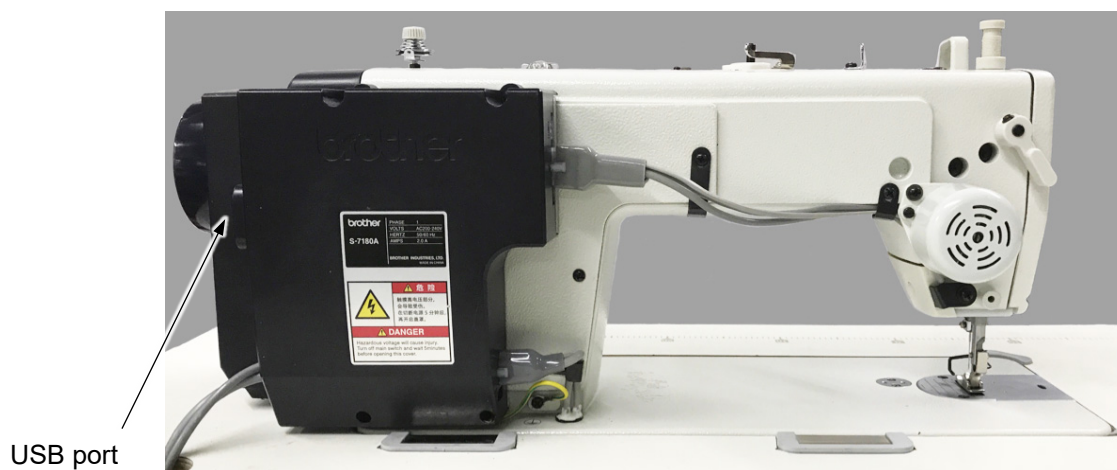

The USB port is located at the following location:

Remove the connector cover before use.



4. Cleaning

⚠ CAUTION

- 
Turn off the power switch before starting work.
 If you step on the treadboard accidentally, the sewing machine may operate and cause injury.
- 
When handling lubricating oil or grease, use protective goggles or gloves to avoid contact with your eyes or skin. Doing so may cause irritation.
Do not swallow or eat lubricating oil or grease. Diarrhea and vomiting may occur.
Keep it out of the reach of children.
- 
When tilting the sewing machine head, fix it so that the table does not move.
Movement of the table may cause injuries such as pinching the foot.
- 
Use both hands to tilt or pull back the machine.
If you do so with one hand, your hand may slip due to the weight of the sewing machine and cause injuries.

To maintain the function of this machine and to use it for a long time, perform maintenance daily as follows.

Also, if the machine has not been used for a long time, perform the following maintenance before using the machine.

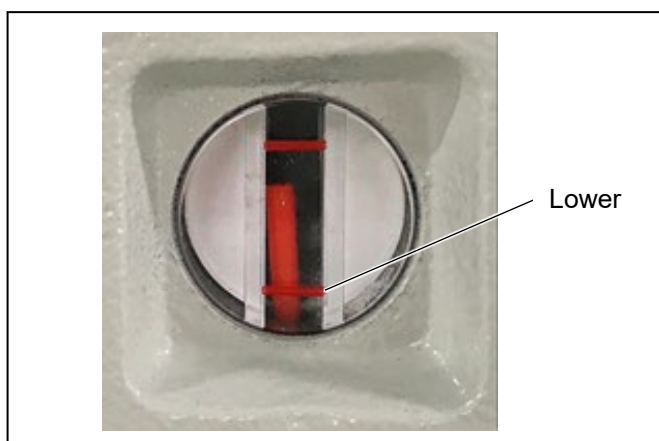

1. When the oil level drops below the baseline of the oil window, be sure to supply oil.

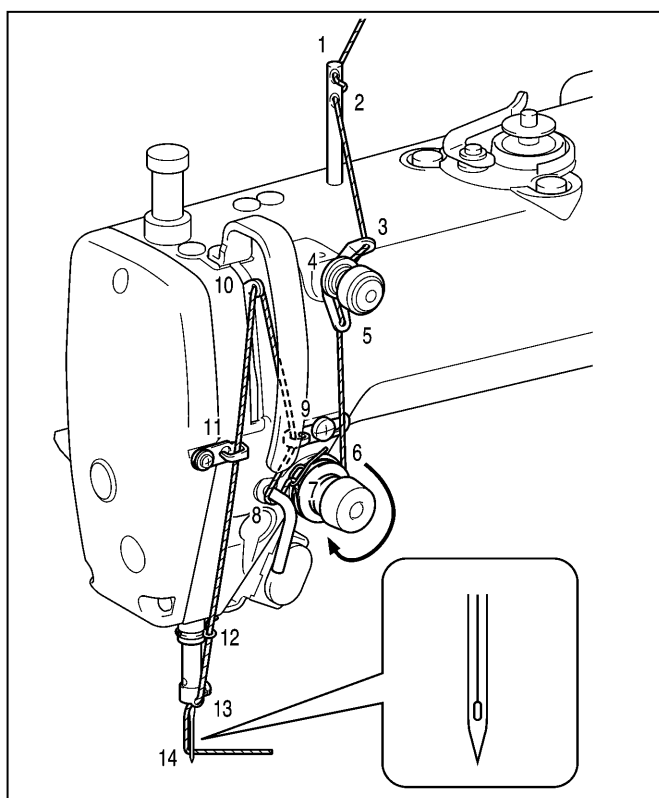

2. Return the machine head.
3. Replace the needle if it is bent or the needle tip is crushed.
4. Check that the needle thread is correctly threaded.
5. Perform a trial sewing.

5. Standard adjustment

⚠ CAUTION

- ⊘ The machine must be serviced by a trained technician.
- ⚠ Have electrical service and inspection performed by a qualified electrician.
- ⚠ If the safety guard is removed, be sure to install it in its original position and check that it functions properly.
- ⚠ When tilting the sewing machine head, fix it so that the table does not move. Movement of the table may cause injuries such as pinching the foot.
- ⚠ Use both hands to tilt or pull back the machine. If you do so with one hand, your hand may slip due to the weight of the sewing machine and cause injuries such as injuries.
- ⚠ Turn off the power switch and unplug the power cord in the following cases:
If the treadle is depressed by mistake, the sewing machine may operate and cause injury.
 - Inspection, adjustment or repair
 - Replacement of consumable parts such as a hook and knife
- ⚠ When opening the motor cover, be sure to turn off the power switch, and then wait for one minute before opening the cover. Touching the motor surface may cause burns.
- ⚠ If you need to make adjustments while the power switch is turned on, use extreme safety precautions.

5-1. Arm thread guide R

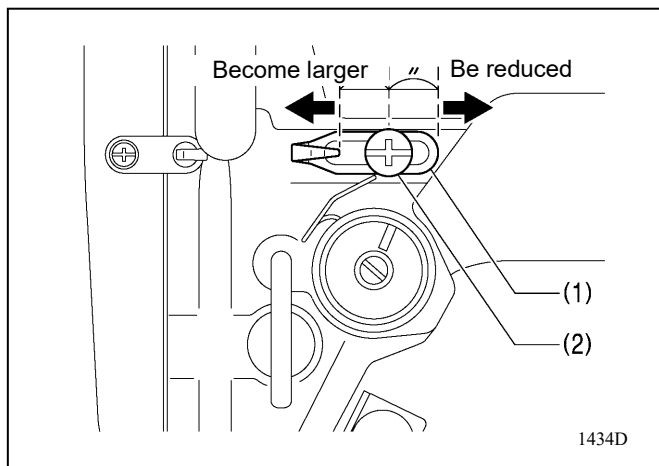

The standard position of the arm thread guide R(1) is that the fastening screw (2) is set at the center of the arm thread guide R(1) adjustment range.

[Precaution]

Adjustment is made by loosening the screw (2) and moving the arm thread guide R (1).

- When sewing heavy objects, move arm thread guide R (1) to the left. (The amount of thread on the balance is increased.)
- When sewing a thin object, move the arm thread guide R (1) to the right. (The amount of thread on the balance is reduced.)

5-2. Height of presser foot

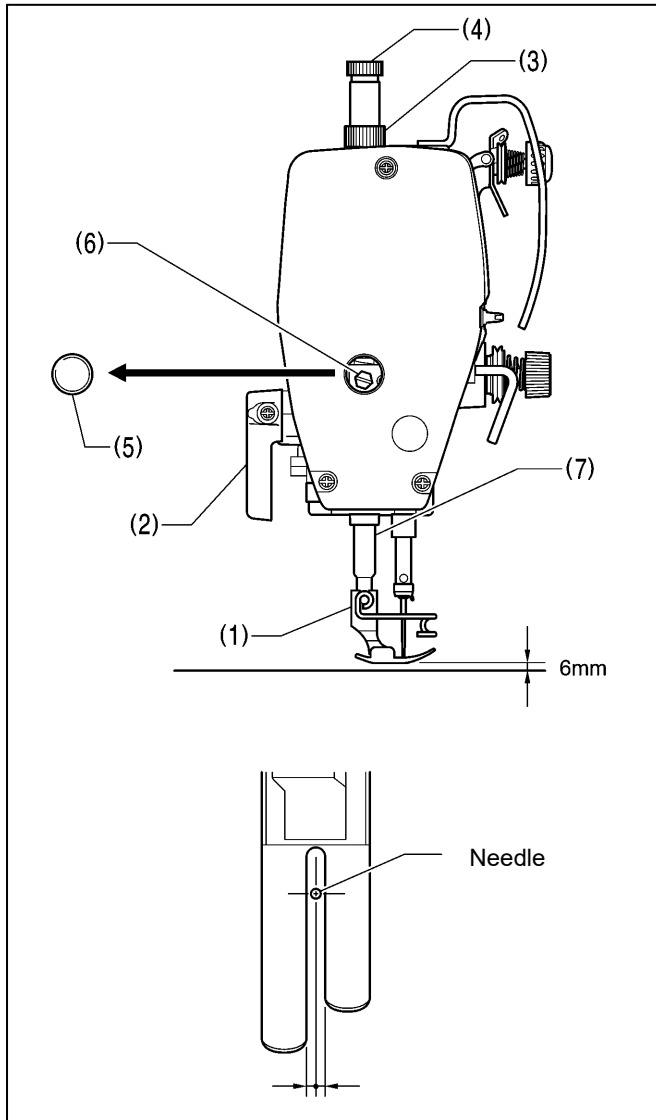

When the presser foot (1) is lifted by the presser foot lifter (2), the standard presser foot lift is 6mm.

1. Loosen the nut (3) and loosen the presser foot adjusting screw (4) so that the presser foot pressure is not applied.
2. Raise the presser foot (1) with the presser foot lifter (2).
3. Remove the rubber stopper (5) on the face plate.
4. Loosen the bolt (6) and move the presser bar (7) up and down to adjust the height of the presser foot (1) to 6mm.
5. Tighten the bolts (6).
6. Attach the rubber stopper (5).
7. Adjust the presser foot pressure with the presser foot adjusting screw (4) and tighten the nut (3).

[Precaution]

After adjustment, turn the sewing machine pulley and confirm that the needle is lowered to the center of the groove of the presser foot.

5-3. Feed dog height

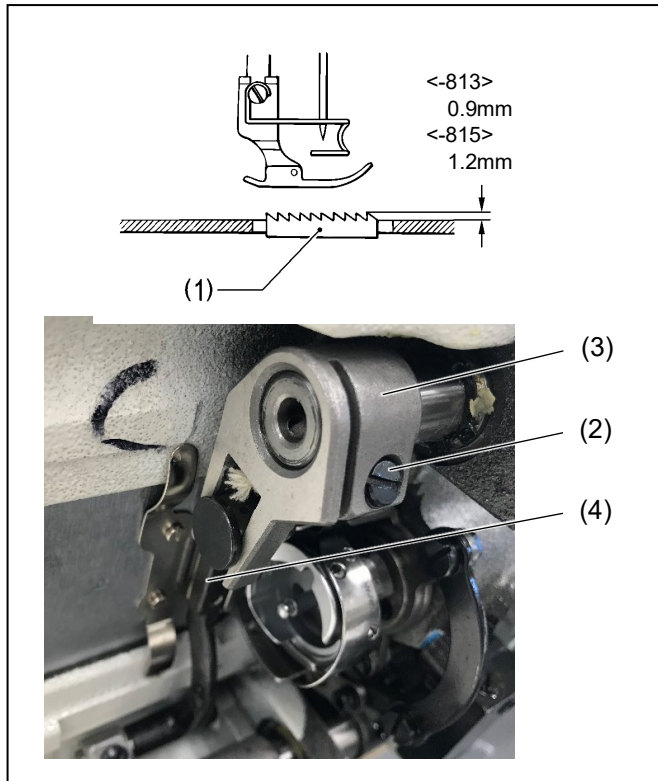

1. Turn on the power.
 2. Set the feed pitch to 5mm. (Panel-set for S-7180A)
- * The standard height when the feed dog (1) is raised most from the top surface of the needle plate is 0.9mm for the-813 specification and 1.2mm for the-815 specification.
3. Turn the sewing machine pulley and stop the feed dog (1) at the uppermost position.
 4. Lower the sewing machine.
 5. Loosen the screw (2).
 6. Turn the vertical feed arm (3) and move the feed bar (4) up and down to adjust.

5-4. Inclination of the feed dog

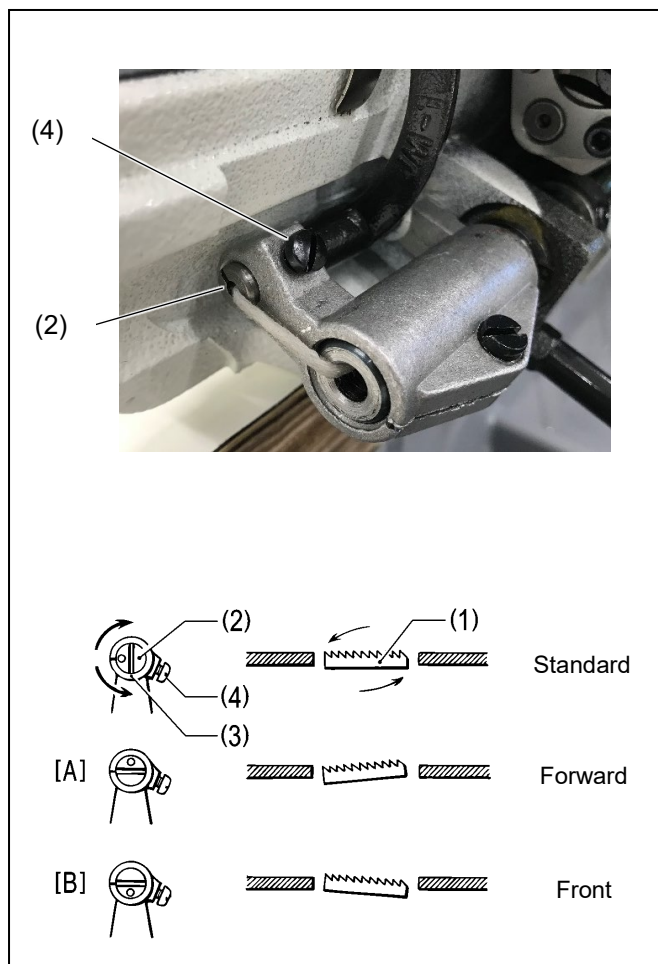

1. Turn on the power.
 2. Set the feed pitch to 5mm. (Panel-set for S-7180A)
- * The standard inclination when the feed dog (1) moves down and coincides with the top surface of the needle plate is the same for the feeder shaft (2) and the horizontal feeder arm (3), and the feed dog (1) is parallel to the needle plate.
3. Turn the sewing machine pulley and stop the feed dog (3) at the uppermost position.
 4. Lower the sewing machine.
 5. Loosen set screw (4) [1 pc.].
 6. Adjust the feed bar shaft (2) to the normal position within 90° in the direction indicated by the arrow.
 - To prevent puckering, lower the inclination of the upper surface of the feed dog (1) toward you. ([B] diagram)
 - To prevent fabric misalignment [sewing no.], raise the inclination of the upper surface of the feed dog (1) toward you. ([A] diagram)
 7. Securely tighten setscrews (4) [1 pc.].

[Precaution]

Adjusting the inclination of the feed dog (1) changes the height of the feed dog (1). Adjust the height of the feed dog (1) again.

5-5. Height of the needle bar

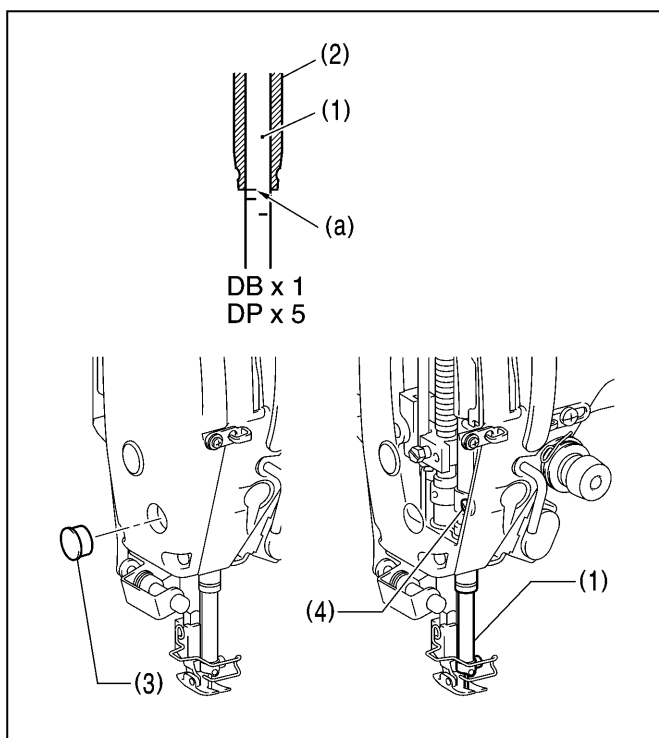

When the needle bar (1) comes to the lowest position, make sure that the base line (a) of the needle bar (1) coincides with the lower end of the needle bar metal (2) as shown in the figure.

1. Turn the sewing machine pulley and set the needle bar (1) to the lowest position.
2. Remove the rubber stopper (3) on the face plate.
3. Loosen the screw (4) and adjust the needle bar (1) by moving it up and down.
4. Tighten the screw (4) securely.
5. Attach the rubber stopper (3).

5-6. Timing of needle and feed

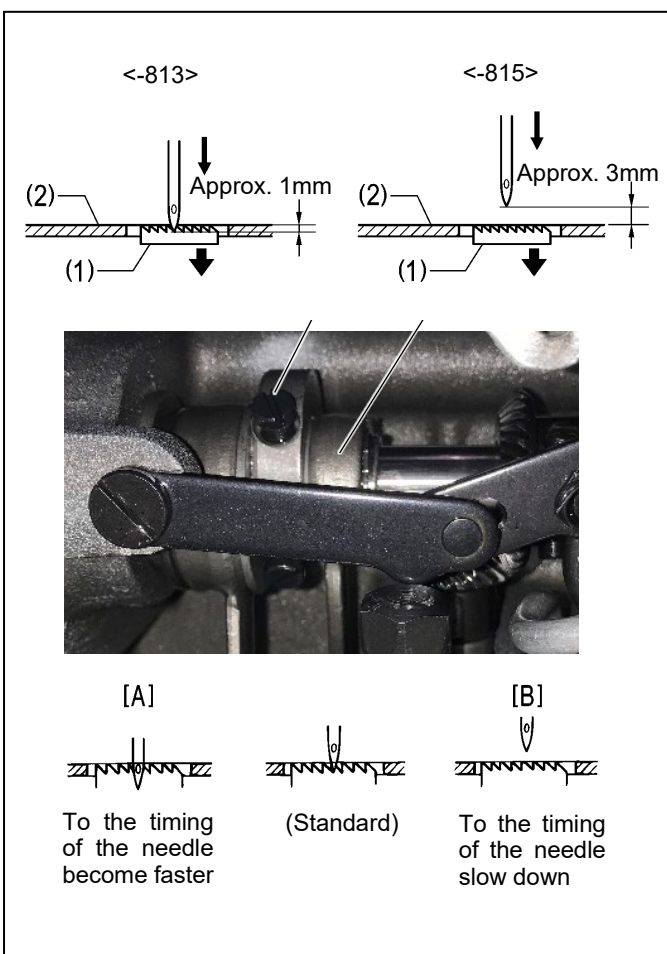

1. Turn on the power.
2. Set the feed pitch to 5mm. (Panel-set for S-7180A)

* When the feed dog (1) is moved down from the uppermost position and coincides with the top surface of the needle plate (2), the needle tip is at the standard position as shown in the figure on the left.

3. Remove the side panels.
4. Loosen the set screws (4) [2 pcs.] of the eccentric wheel and adjust by turning the eccentric wheel (3) slightly.
 - To advance the needle timing, turn in the direction of <A>. To delay the needle timing, turn in the direction of .
 - Delay the timing of the needle to prevent fabric misalignment (eventually sewing). ([B] diagram)
 - Timing of the needle is advance to improve thread tightness. ([A] diagram)

[Precaution]

Turning the eccentric wheel (3) too far in the direction of <A> may cause needle breakage.

5. After adjustment, tighten the set screw (4) securely.
6. Replace the side panels.

5-7. Timing of the needle and the hook

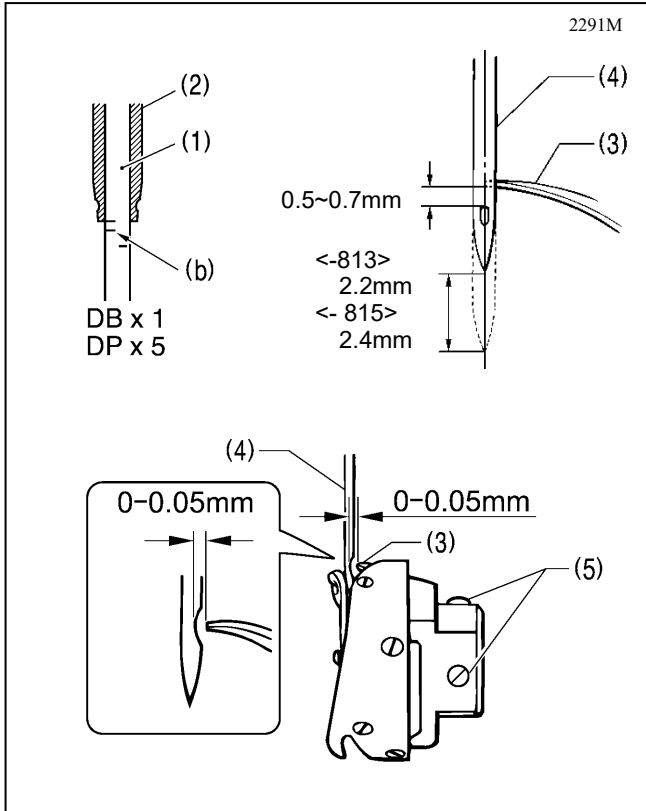

When the needle bar (1) rises 2.2mm (-813 specification) and the -815 specification is 2.4mm) above the lowest position and the base line (b) coincides with the lower end of the needle bar bush (2) as shown in the figure, the hook tip (3) should coincide with the center of the needle (4).

(At this time, the clearance between the top edge of the needle hole and the tip of the hook blade is 0.5 to 0.7mm.)

1. Turn the sewing machine pulley to raise the needle bar (1) from the lowest position and align the base line (b) with the lower end of the needle bar bush (2) as shown in the figure.
2. Loosen setscrews (5) [3 pieces] and align hook blade tip (3) with the center of needle (4).
At this time, the clearance between the tip of the hook (3) and the needle (4) should be 0 to 0.05mm.
3. Securely tighten the set screws (5) [3 pcs.].

5-8. Adjusting the amount of oil supply to the hook

! CAUTION



When checking the amount of oil supplied to the hook, make sure that your fingers and the oil level check paper do not touch moving parts such as the hook and feeding mechanism. May cause injury.

When changing the hook or changing the sewing speed, adjust the oil supply amount of the hook according to the following procedure.

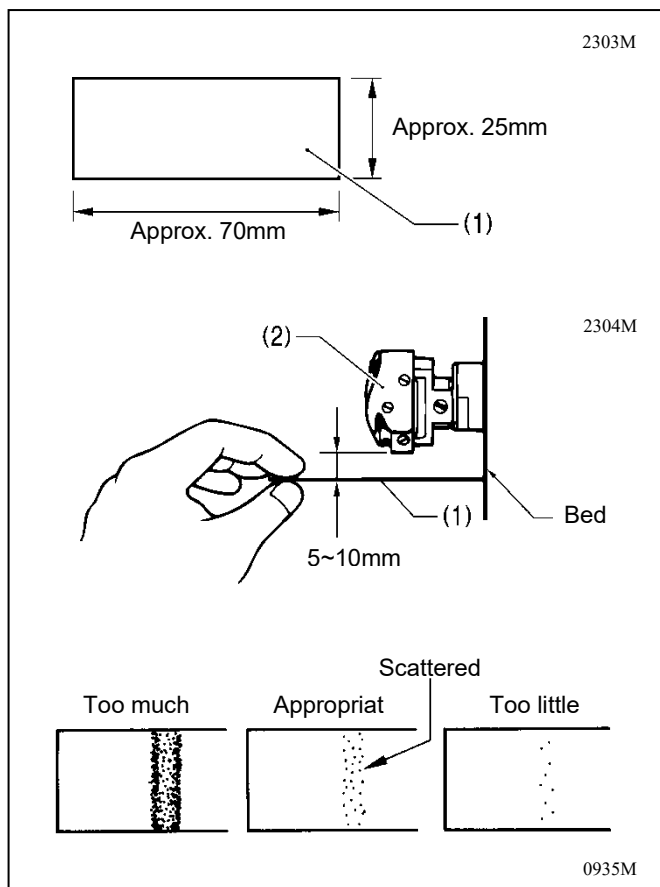

<Checking the Lubrication Amount>

1. Remove the upper thread from the balance to the needle.
2. Raise the presser foot with the presser foot lifter.
3. Run the sewing machine for approximately 1 minute at the actual sewing speed [moderate intermittent operation].
4. Insert the oil level check sheet (1) into the bottom of the hook (2) and hold it, and run the sewing machine for eight seconds at the actual sewing machine speed.
(Any paper quality can be used for the oil level check sheet (1).)
5. Check the amount of oil scattered on the paper.

When adjustment is necessary, perform the following steps <Adjusting the Lubrication Amount>.

<Adjusting the Lubrication Amount>

1. Lower the sewing machine.
2. Turn the oil adjusting screw (3) to adjust the amount of lubrication.
 - Turn the oil adjusting screw (3) to the left to increase the amount of lubrication.
 - Turn the oil adjusting screw (3) clockwise to decrease the amount of lubrication.
3. Check the amount of lubrication referring to "Checking the amount of lubrication" above.

[Precaution]

Repeat adjusting the oil adjusting screw (3) and checking the oil supply until the proper oil level is achieved.

4. Check the lubrication amount again after sewing for approx. 2 hours

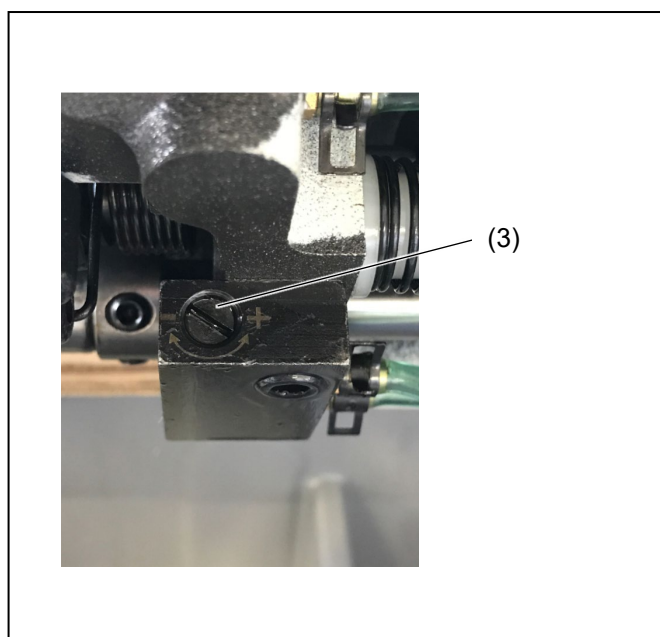

5-9. Adjusting the Upper Shaft Lubrication Amount

1. Remove the face plate and turn the upper shaft lubrication screw (1) to adjust the amount of lubrication.

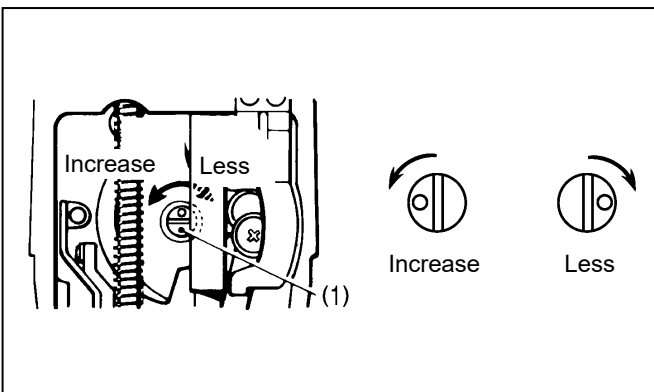
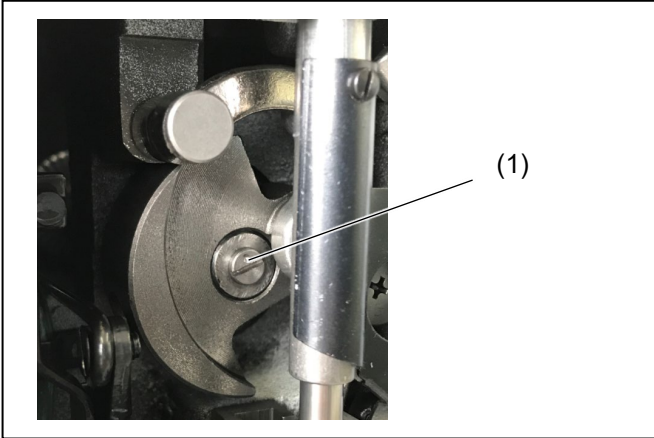

5-10. Thread trimmer

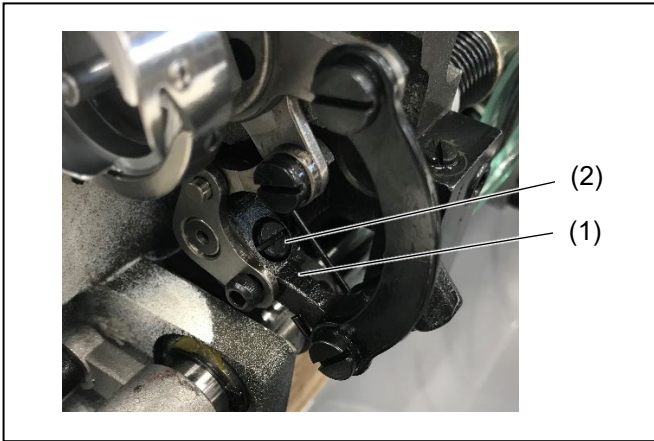

1. Turn off the power switch.
2. Remove the presser foot, needle plate and feed dog.
3. Lower the sewing machine head.
4. Loosen the screw (2) of the thread trimmer lever (1).
(Operate the upper and lower female holders and needle bar mechanism independently.)

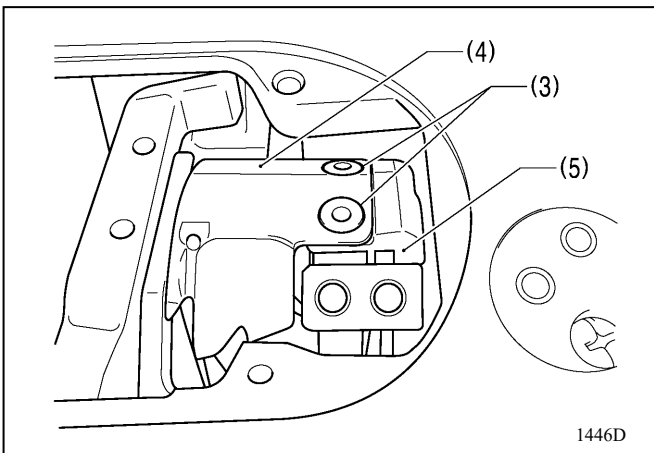

5. Attach the lower knife (4) to the lower knife holder (5) with the tightening screws (3) [2 pcs.].

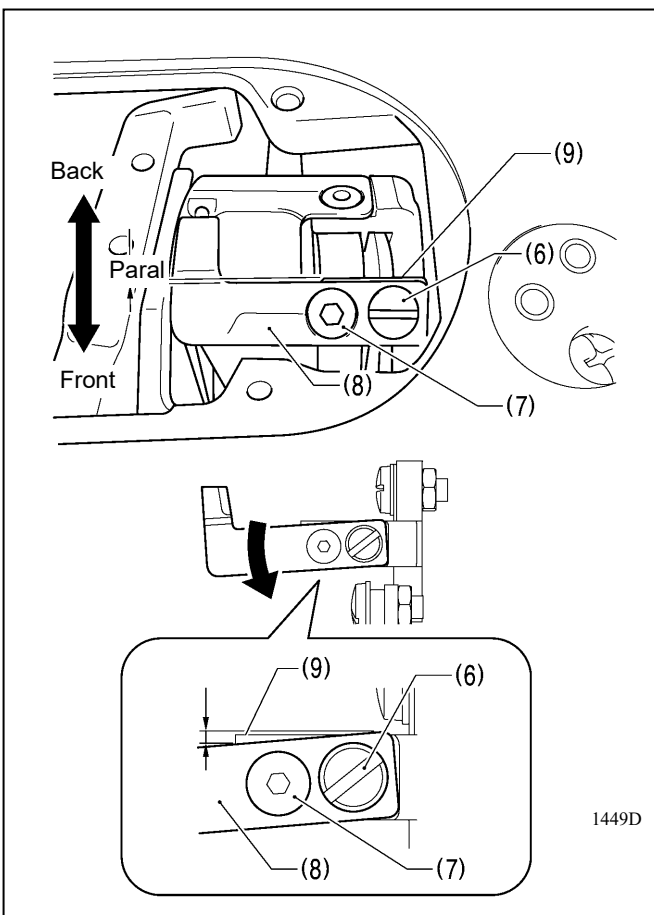

6. Attach the upper knife (8) with the fastening screws (6) and (7).

- * Mount the upper knife (8) so that it is almost parallel to the mounting surface edge line of the upper knife holder (9).
- * Tilting the upper knife (8) to the front side increases the blade pressure, and tilting it to the back side decreases the blade pressure.
- * After adjustment, operate the upper and lower knife holders by hand to confirm that the thread breaks.

- * If a thick thread is used or the thread cannot be broken, adjust the inclination of the upper knife (8) to the front side.
- * Tilt the upper knife (8) to the front side so that the mounting surface ridge line of the upper knife holder (9) is slightly visible (max. 0.3mm). (The screw head of the fastening screw (7) is countersunk, so the upper knife (8) can be tilted around this screw.)

Be careful not to tilt the upper knife too much, as it may get under the lower knife and be damaged.

5. Standard adjustment

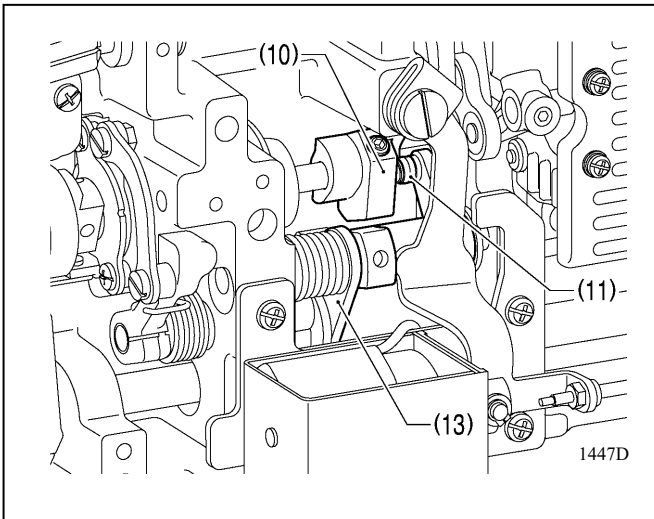

7. With the thread trimmer solenoid in the ON position, rotate the sewing machine pulley and move the thread trimmer cam roller (11) to the maximum displacement position with the thread trimmer cam (10).
- * Be careful not to return the thread trimmer solenoid to the OFF state halfway.

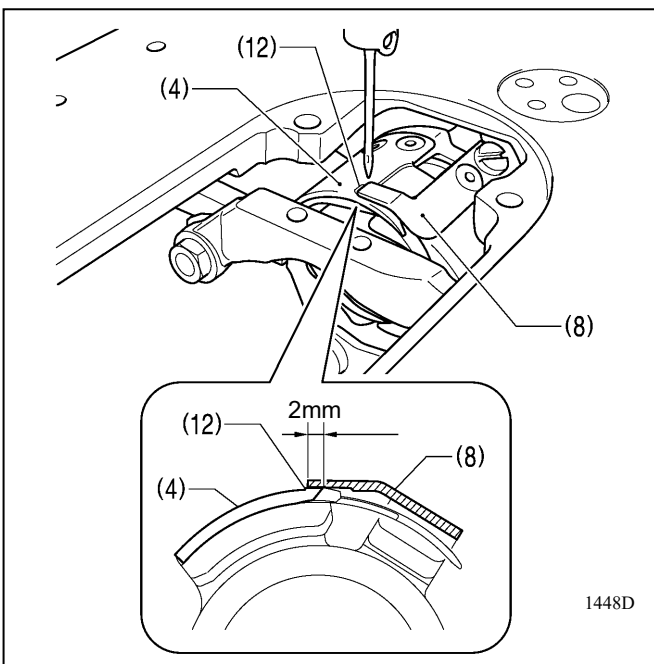

8. Set the maximum engagement amount of the upper and lower knives to 2mm.
- * Rotate the thread trimmer lever (1) to align the tip of the upper knife (8) with the center of the takin (12) of the lower knife (4).
 - * Be careful that the cutting edge of the upper knife (8) does not exceed the mark (12).

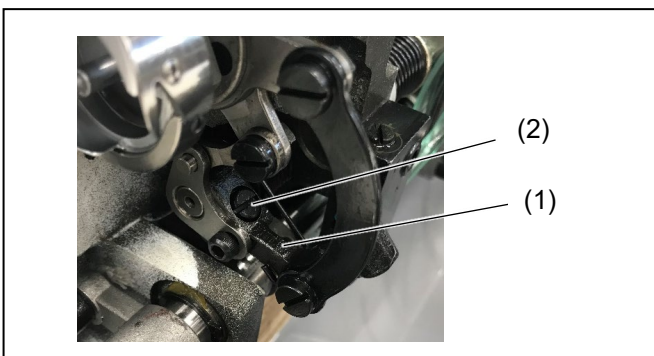

9. Tighten the screw (2) of the thread trimmer lever (1).
- * Be careful not to rattle the thread trimmer lever (1) and forked shaft (13) in the thrust direction.

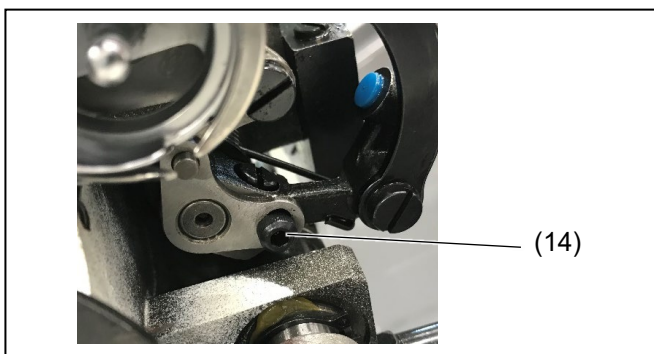

- * Loosen this bolt (14) to fine-tune the amount of engagement.

<Adjusting the position of the thread trimmer cam>

1. Turn the sewing machine pulley to move the needle bar up 6mm from the lowest position [base line (a) position] and align the base line (b) with the lower end of the needle bar metal.

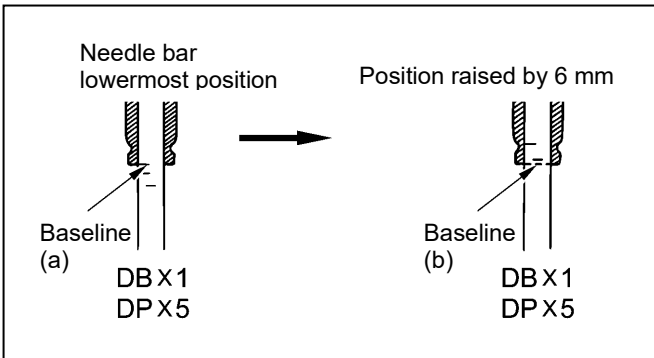

2. Under the above conditions, push the plunger (1) of the thread trimmer solenoid in the direction of the arrow with your finger.

Adjust the position of the thread trimmer cam (2) so that the roller shaft (4) of the thread trimmer cam lever set (3) comes into contact with the bore (c) of the thread trimmer cam (2) and the clearance between the end face of the thread trimmer cam (2) and the roller shaft (4) is 0.5 to 1.0mm. Then tighten the set screw (5). ([A] diagram)

3. Check that the end face of the thread trimmer cam (2) and the roller shaft (4) do not come into contact when the roller shaft (4) is returned to the right.

([B] diagram)

- * Tighten the set screws (5) [2 pcs.] with approx. 4N·m.

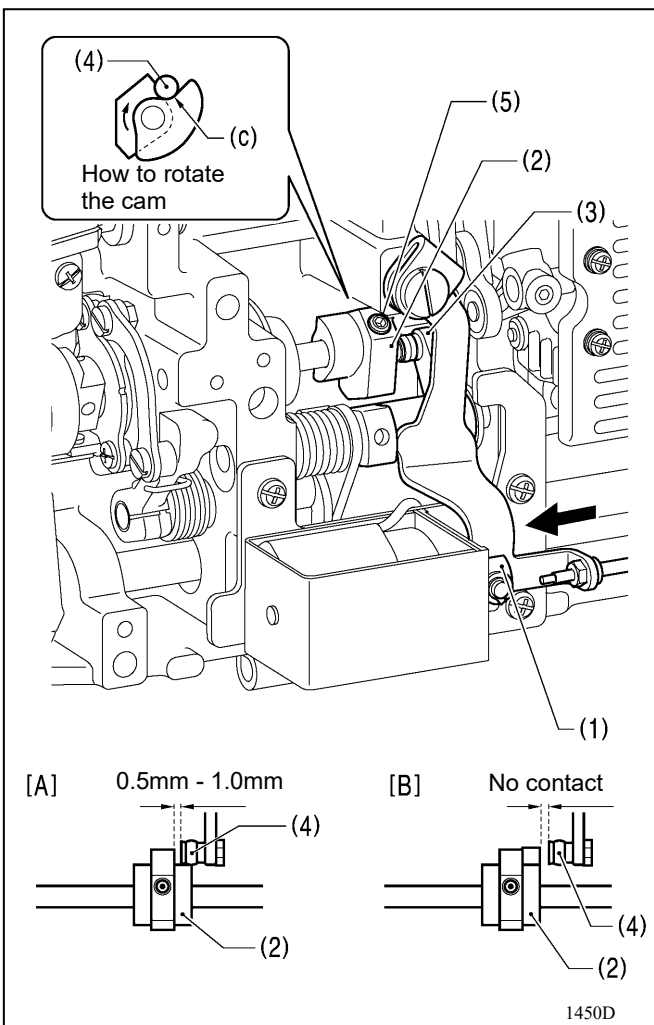

6. In the following cases

- Check the following points before contacting us for repair or service.
- If the problem is not resolved by the following measures, turn off the power switch and contact a trained technician or your dealer.



⚠ CAUTION





Turn off the power switch and unplug the power cord before starting work.
If you step on the treadboard accidentally, the sewing machine may operate and cause injury.

6-1. Sewing-related

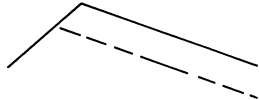
Items marked with an asterisk (*) on the reference page should be examined by a trained technician.

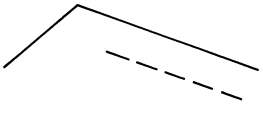
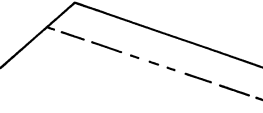
Phenomenon	As you look into	Reference page
<p>1 The needle thread does not tighten.</p>  <p style="text-align: right;">0573M</p>	<ul style="list-style-type: none"> · Check if needle thread tension is too low. Or, is the bobbin thread tension too strong? Adjust the needle thread tension and bobbin thread tension. · Is the timing of the needle and feed appropriate? Please expedite the timing of the guideline. 	30*
<p>2 Bobbin thread does not tighten</p>  <p style="text-align: right;">0574M</p>	<ul style="list-style-type: none"> · Check if needle thread tension is too strong. Or, is the bobbin thread tension too weak? Adjust the needle thread tension and bobbin thread tension. 	
<p>3 Improper thread tightening of towel eyes, etc.</p>  <p style="text-align: right;">0977M</p>	<ul style="list-style-type: none"> · Check that the thread guide is not slipping properly. Polish each thread guide with fine paper file or buffing, etc. · Are there bad slippage of the bobbin? Pull out the bobbin thread and check if there is any unevenness in the tension of the thread. Replace the bobbin or bobbin case. 	
<p>4 Skipping in the middle of sewing</p>  <p style="text-align: right;">0470M</p>	<ul style="list-style-type: none"> · Check if the needle tip is bent. Is the needle tip crushed? Replace the needle if it is bent or crushed. · Are you wrong with how to attach the needle? If it is wrong, attach the needle correctly. · Is there a mistake in threading? If it is wrong, thread correctly. · Is the presser foot pressure too weak? Adjust the presser foot pressure. · Check if the needle is too fine. Replace with a thicker 1-rank needle. · Check if the presser foot is floating. Adjust the height of the presser foot. · Check if the thread take-up spring is too weak. Adjust the strength of the thread take-up spring. · Check that the timing of the needle and the hook are correct. Adjust the height of the needle bar. Adjust the gap between the needle and the hook tip. 	<p>25</p> <p>28*</p> <p>*</p> <p>30*</p> <p>31*</p>

	Phenomenon	As you look into	Reference page
5	<p>Skipping at the start of sewing Thread missing at the start of sewing</p>  <p style="text-align: right;">0479M</p>	<ul style="list-style-type: none"> · Check if the thread take-up spring is too strong. Reduce the strength of the thread take-up spring. · Check if the thread take-up spring has an excessive operating range. Lower the position of the thread take-up spring. · Check that the remaining amount of needle thread from the needle hole is not short after thread trimming. Adjust the pretension. · Isn't the thread not sharp? Grind or replace the fixed blade with an oilstone. Replace the moving blade. · Check if the needle is too thick. Replace the needle with a narrow one. · Check that the bobbin thread protruding from the bobbin case is not too short after thread trimming. Replace the anti-slip spring of the bobbin case if the bobbin idles. · Is the speed at the start of sewing too fast? Set the operation panel with slow start. · Is the needle upward stop position too high? Adjust the needle upward stop position. 	<p style="text-align: center;">*</p> <p style="text-align: center;">*</p> <p style="text-align: center;">26*</p> <p style="text-align: center;">20*</p> <p style="text-align: center;">23*</p>
6	<p>Uneven seam</p>  <p style="text-align: right;">0473M</p>	<ul style="list-style-type: none"> · Is the presser foot pressure too weak? Adjust the presser foot pressure. · Is the height of the feed dog too low? Adjust the height of the feed dog. · Is the bobbin scratched? If it is damaged, correct it. Or replace the bobbin. 	<p style="text-align: center;">29*</p> <p style="text-align: center;">*</p>
7	<p>Have more puckering (Too tight)</p>  <p style="text-align: right;">0978M</p>	<ul style="list-style-type: none"> · Check if needle thread tension is too strong. Decrease the needle thread tension as much as possible. · Check if bobbin thread tension is too strong. Lower the bobbin thread tension as much as possible. · Is the needle tip crushed? Replace the needle if it is crushed. · Check if the needle is too thick. Replace the needle with a smaller one as much as possible. · Check if the thread take-up spring is too strong. Decrease the strength of the thread take-up spring as much as possible. · Check if the thread take-up spring has an excessive operating range. Lower the position of the thread take-up spring as much as possible. · Is the presser foot pressure too strong? Adjust the presser foot pressure. · Is the sewing speed too fast? Set the maximum sewing speed slower in small increments on the operation panel. · Is the inclination of the feed dog appropriate? Keep the feed tooth slightly down. 	<p style="text-align: center;">*</p> <p style="text-align: center;">*</p> <p style="text-align: center;">15*</p> <p style="text-align: center;">29*</p>

6. In the following cases

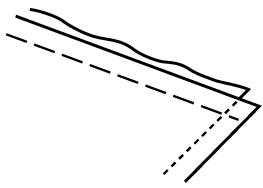
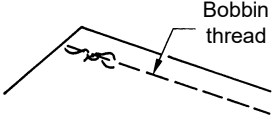
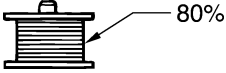
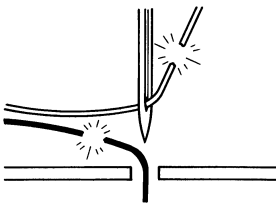
	Phenomenon	As you look into	Reference page
8	Sewing end  0750M	<ul style="list-style-type: none"> Is the presser foot pressure too strong? Adjust the presser foot pressure. 	
9	Bobbin thread is caught at the start of sewing Idling of the bobbin during thread trimming  0751M	<ul style="list-style-type: none"> Check that the rotation direction of the bobbin when the bobbin thread is pulled is correct. Set the rotation direction of the bobbin opposite to the rotation direction of the hook. Is the bobbin thread winding amount too large? The bobbin thread winding amount should be up to 80%.  2124M Is the anti-slip spring installed? Install an anti-slip spring. Are there bad slippage of the bobbin? If slippage is poor, replace the bobbin. Is the bobbin made of a light alloy specified by Brother? Replace with the specified bobbin. 	
10	The needle thread and bobbin thread are broken.  0471M	<ul style="list-style-type: none"> Check if the needle tip is bent. Is the needle tip crushed? Replace the needle if it is bent or crushed. Are you wrong with how to attach the needle? If it is wrong, attach the needle correctly. Is there a mistake in threading? If it is wrong, thread correctly. Check if needle thread tension or bobbin thread tension is too strong or too weak. Adjust the tension of the needle thread and bobbin thread. Check if the needle thread is loose because the thread take-up spring has a small amount of operation. Adjust the position of the thread take-up spring. Check that the hook and feed dog are not damaged. If it is damaged, polish it with an oilstone, etc. Alternatively, replace the damaged part. Check the thread guides for damage. If it is damaged, polish it with paper, etc. Alternatively, replace the damaged part. 	25 25* * *
11	Thread trimming error (both upper and lower threads are not broken.)	<ul style="list-style-type: none"> Are there any scratches or wear and tear on the blade of the fixed blade or moving blade? Replace the fixed blade and moving blade. 	26*
12	Thread trimming error (The needle thread cannot be broken.) (Bobbin thread does not break.)	<ul style="list-style-type: none"> Are you wrong with how to attach the needle? If it is wrong, attach the needle correctly. Is the fixed blade or moving blade not sharp? Replace the fixed blade and moving blade. 	26*

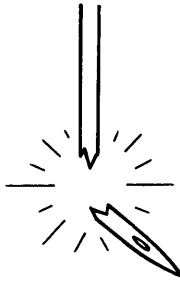
	Phenomenon	As you look into	Reference page
13	Needle breakage  0469M	<ul style="list-style-type: none"> · Whether the cloth is forcibly pulled or pushed during sewing. · Are you wrong with how to attach the needle? If it is wrong, attach the needle correctly. · Check if the needle tip is bent. Are the needle tips crushed or clogged? Replace the needle. · Check that the timing of the needle and the hook are correct. Adjust the height of the needle bar. Adjust the gap between the needle and the hook tip. · Check whether the timing of the needle is too fast for the feed dog. Delay the timing of the needle. <div style="border: 1px solid black; padding: 5px; margin-top: 10px;"> <p>Caution</p> <ul style="list-style-type: none"> · A broken needle can be very dangerous if it gets caught in sewn objects, etc. Search for debris until the shape of the needle can be restored. · We also recommend thorough needle management as a measure against the PL Law, such as keeping these needles on records. </div>	30* 31* 30*
14	The sewing machine does not operate even when the power switch is turned on and the treadboard is stepped on.	<ul style="list-style-type: none"> · Check whether the power connector of the control box is disconnected. Securely insert the cable. 	7~10
15	Cannot operate at high speed	<ul style="list-style-type: none"> · Check whether sewing speed and sewing stop speed are set slower. Set the maximum sewing speed to high. 	15*
16	Nothing is displayed on the operation panel.	<ul style="list-style-type: none"> · Check whether the power connector of the control box is disconnected. Securely insert the cable. · Check whether the control box operation panel connector is disconnected. Securely insert the cable. 	7~10 7*
17	Illumination goes dark or flickers for a moment	<ul style="list-style-type: none"> · Depending on the power supply environment, the lighting may become dim or flicker momentarily when the sewing machine is started or stopped. This is not a malfunction. 	*

brother

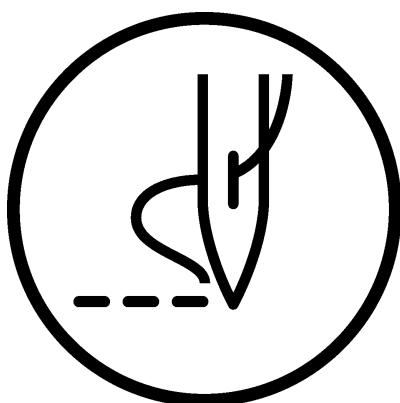

INSTRUCTION MANUAL

* Due to product improvements, some of the contents of this manual may differ from the products you purchased.

BROTHER INDUSTRIES, LTD. <http://www.brother.com/>
1-5, Kitajizoyama, Noda-cho, Kariya 448-0803, Japan. Phone : 81-566-95-0088

© 2021 Brother Industries, Ltd. All Rights Reserved.

This is the original instructions.

S-7180A
I1031562Z E
2021.07.Z (1)